

***BOSE***<sup>®</sup>

**Bose<sup>®</sup> 3•2•1  
and 3•2•1 GS Home  
Entertainment Systems**

**Owner's Guide  
August 18, 2003**

*AM271966\_00\_V.pdf*

The AV3-2-1 and AV3-2-1 GS media centers are to be used only with the PS3-2-1 or PS321 powered speaker system (Acoustimass® module).

**⚠ WARNING:** To reduce the risk of fire or electric shock, do not expose the system to rain or moisture.

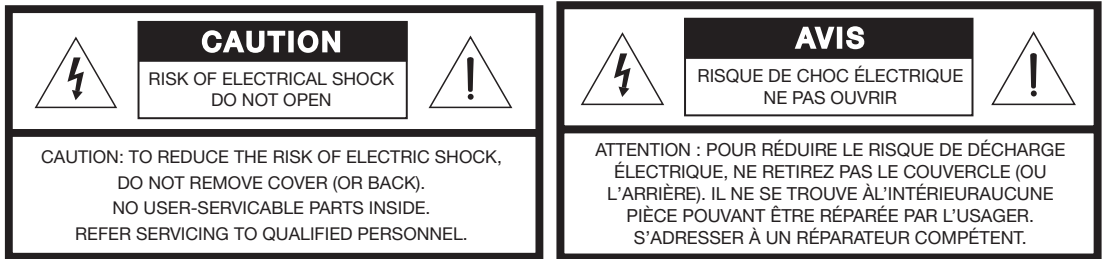

These CAUTION marks are located on the bottom of your 3•2•1 home entertainment system media center and the rear panel of the Acoustimass module:



The lightning flash with arrowhead symbol, within an equilateral triangle, is intended to alert the user to the presence of uninsulated dangerous voltage within the system enclosure that may be of sufficient magnitude to constitute a risk of electric shock.



The exclamation point within an equilateral triangle, as marked on the system, is intended to alert the user to the presence of important operating and maintenance instructions in this owner's guide.

**⚠ CAUTION:** To prevent electric shock, match wide blade of plug to wide slot, insert fully.

**⚠ CAUTION:** No naked flame sources, such as lighted candles, should be placed on the apparatus.

### Class 1 laser product

The DVD player contained within the media center is classified as a CLASS 1 LASER PRODUCT according to EN60825-1:1994 + A11. The CLASS 1 LASER PRODUCT label is located on the bottom of the media center.

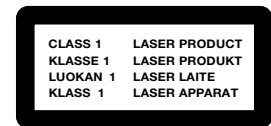

**⚠ CAUTION:** Use of controls or adjustments or performance of procedures other than those specified herein may result in hazardous radiation exposure. The DVD player should not be adjusted or repaired by anyone except properly qualified service personnel.

### Batteries

Please dispose of used batteries properly, following any local regulations. Do not incinerate.

Batteries



### Please read this owner's guide

Please take the time to follow this owner's guide carefully. It will help you set up and operate your system properly, and enjoy all of its advanced features. Save your owner's guide for future reference.

**Where to find...**

Safety Information .....	2
Contents .....	3
Before you begin .....	5
Selecting compatible discs .....	5
How text is used in this owner's guide .....	5
Glossary of terms .....	6
For your records .....	7
Unpacking .....	8
Finding the product serial numbers .....	8
Selecting locations for your 3•2•1 home entertainment system components .....	9
Placing the media center .....	9
Placing the 3•2•1 speakers .....	9
Placing the Acoustimass® module .....	12
When the system setup is completed .....	13
Making the connections .....	14
Additional cables .....	14
Connecting the 3•2•1 speakers .....	14
Connecting the Acoustimass module .....	15
Attaching the supplied antennas .....	16
FM antenna .....	16
AM antenna .....	16
Connecting cable FM radio .....	16
Connecting your TV to the media center .....	17
S-video as an alternate means to connect to the TV .....	18
Turning off the internal speakers in your TV .....	18
System Setup .....	19
Connecting your TV and VCR to the media center .....	19
If your TV has audio output jacks .....	19
If your TV does not have audio output jacks .....	21
Making the final power connection .....	22
Installing remote control batteries .....	23
Connecting other sources .....	23
Guidelines for connecting other components .....	23
Connecting recording equipment .....	25
Connecting other playback equipment .....	25
Connecting digital audio components .....	25
Turning on the system .....	26
The remote control .....	26
POWER and MUTE controls .....	26
SOURCE controls .....	26
SOURCE and MENU controls .....	27
PLAYBACK controls .....	27
The advanced remote control .....	28
Enhanced controls .....	28
Programming the advanced remote .....	28
The media center .....	29
Control panel and buttons .....	29
Display indicators .....	29
TV on-screen menus .....	30
To enter the Settings menu .....	30
To leave the Settings menu .....	30
Operation .....	32
Turning your system on and off .....	32
Before you play your first DVD .....	32
Loading and playing a DVD .....	32
Basic DVD operations .....	33
Using the Parental Control feature to restrict future play .....	34
Parental Control submenu .....	34

English

Español

Français

Appendix

DVD-specific behavior	34
DVD play options	35
Loading and playing a CD	36
Basic CD operations	36
Changing CD settings	37
Using the sleep timer	37
Using the radio	37
Tuning	37
Storing preferred stations as preset selections	38
Selecting a preset station	38
Changing FM settings	38
Changing AM settings	39
Playing other sources	39
Changing settings for the other sources	39
System settings	39
Sound Adjustments	40
Locating Audio Setup	40
Audio Setup menu	40
Locating system settings	42
System Setup menu	43
DVD Setup submenu	43
Reference	44
Taking care of your 3•2•1 or 3•2•1 GS system	44
Cleaning the media center	44
Cleaning the speakers	44
Cleaning discs	44
Replacing the remote batteries	44
Troubleshooting	45
Customer service	46
Warranty	46
Accessories	46
Technical information	47
Appendix	A1
Setup codes for cable	A1
Setup codes for satellite	A3
Setup codes for television	A8

## Before you begin



Thank you for purchasing the Bose® 3•2•1 or 3•2•1 GS home entertainment system, which offers superb sound, elegance, and simplicity in an advanced home audio setup. Using Bose proprietary signal processing technology, the 3•2•1 systems provide improved spaciousness from stereo recordings, and bold movie effects from surround-encoded materials. Yet its few parts require little effort to set up, so you can enjoy your new system's performance right away.

Your system includes:

- Integrated AM/FM tuner and DVD/CD player in a small console
- Small, easy-to-place shelf speakers and an attractive floor-standing Acoustimass® module
- Easy-to-use infrared remote control
- Console input jacks for connecting other source components (such as a VCR, DSS, CD changer, or tape deck)

### Selecting compatible discs

The DVD/CD player built into the 3•2•1 media center can play the following types of discs identified by their corresponding logos:

- Video DVDs 
- Audio CDs 
- CD-R and CD-R/Ws
- MP3 on CD

### Check for region code compatibility

For a DVD player and DVD disc to be compatible, their region code numbers must match. These numbers are allocated according to where the player and disc are sold. The 3•2•1 home entertainment system has a region code which must also match the DVD discs. The user cannot change the 3•2•1 home entertainment system's region code. Therefore, the system should be purchased in the region in which it will be used.

Check the region code number on the carton of the 3•2•1 home entertainment system or on the bottom of the media center that comes in the carton. Then be sure to choose only DVD discs that show the same region number on the disc label or front cover. For example, a Region 1 DVD disc should display the following mark: 

### MP3 playability

To be compatible with the 3•2•1 or 3•2•1 GS home entertainment systems, MP3s must meet the following criteria: 1) All tracks must be burned in a single closed session; 2) The disc format must be ISO9660; 3) Each file must have a ".mp3" extension and have no other periods in the filename; 4) Although the system does not display ID3 tag information, the system may not recognize files with tags higher than ID3 (ID3v1).

## How text is used in this owner's guide

These instructions refer to buttons on the remote control and on the media center front panel, menu items that appear on your TV screen, and status indicators on the media center display. To help you differentiate them:

**Button names** appear in bold type. If a button has only a symbol, that alone will be used.

**On-Screen Display messages** appear in bold type with a line above and below.

**MEDIA CENTER DISPLAY** items are represented by bold capitalized type

Important guidelines for trouble-free performance of your home entertainment system (and its additional components) are shown in gray boxes.

## Glossary of terms

**DD** – The trademarked logo for Dolby® Digital, a perceptual coding system for audio, developed by Dolby Laboratories. Dolby Digital is the most common means of encoding audio for DVD-Video.

**Aspect Ratio** – The shape of the rectangular picture in a TV set. It is the width of the picture relative to the height. Our standard TV picture, in terminology used by that industry, is 4 units wide by 3 units high, or 4:3 (read as 4 by 3) in aspect ratio. There are currently two standard TV aspect ratios, 4:3 and 16:9.

**Chapter** – In DVD-Video, a division of a title. Technically called a part of title (PTT).

**Composite Video** – A single video signal that contains luminance, color, and synchronization information. NTSC and PAL are examples of composite video systems.

**Dolby\*** – a source of audio encoder technology.

**Dolby Digital** (also called 5.1) – a type of multi-channel surround sound format used on discs.



**D I G I T A L** – the logo representing the above.

**DTS** – a type of multi-channel surround sound format used on discs.



– the logo representing the above.

**DVD** – An acronym that is most commonly known to mean Digital Video Disc or Digital Versatile Disc. The audio/video/data storage system based on 12- and 8-cm optical discs.

**DVD Video** – A standard for storing and reproducing audio and video on DVD-ROM discs, based on MPEG video, Dolby Digital and MPEG audio, and other proprietary data formats.

**IR** – An acronym for infrared. Pertains to the type of remote that sends/receives commands on an infrared light beam.

**Letterbox** – The projected aspect ratio of feature films is often 16:9 rather than the 4:3 aspect ratio of most TVs. Therefore, it is becoming common practice to transfer films to video with black borders at the top and bottom of the picture. The film picture becomes a “letterbox” within the video.

*\*Dolby and the double-D symbol are trademarks of Dolby Laboratories. Manufactured under license from Dolby Laboratories.*

*Confidential unpublished works. 1992-1997 Dolby Laboratories. All rights reserved.*

*This product incorporates copyright protection technology that is protected by method claims of certain U.S. patents and other intellectual property rights owned by Macrovision Corporation and other rights owners. Use of this copyright protection technology must be authorized by Macrovision Corporation, and is intended for home and other limited viewing uses only unless otherwise authorized by Macrovision Corporation. Reverse engineering or disassembly is prohibited.*

*“DTS” and “DTS Digital Surround” are registered trademarks of Digital Theater Systems, Inc.*

*MPEG Layer-3 audio compression technology licensed by Fraunhofer IIS and THOMSON multimedia.*

*This product incorporates copyright protected technology and other intellectual property rights owned by Cirrus Logic, Inc. and subject to the copyright protection of the U.S. as well as other licensing restrictions and protections. Use of this copyright protected technology is limited solely to use with the Cirrus Logic integrated circuits incorporated in this product. Reverse engineering or disassembly is prohibited.*

**MPEG** – a type of data compression used for audio or video storage on disc.

**MP3** – MPEG-1 Layer III audio. This is a compressed audio format that allows you to record many hours of music on a single CD.

**NTSC** – An acronym for National Television System Committee. The organization that developed both the American Black & White and Color television system.

**PAL** – An acronym for Phase Alternate Line. This is one of several composite video systems. The PAL format is used extensively in Western Europe.

**PCM** – An uncompressed, digitally coded representation of an analog signal. This is the form of the digital audio signal used for both CD and laserdisc. It is a serial data stream that is coded for transmission or recording. PCM is also used for many other types of serial data communications.

**S-video** – A video interface standard that carries separate luminance and chrominance signals, usually on a four-pin mini-DIN connector. Also called Y/C. The quality of S-video is significantly better than composite video since it does not require a comb filter to separate the signals. Most high-end televisions have S-video inputs.

**Title** – numbered elements of the DVD contents, which may include more than the movie alone.

**Track** – Individual selections recorded on an audio tape or disc.

## ***For your records***

Serial numbers are located on the bottom of the media center and the rear of the Acoustimass® module. Please have your serial number ready before contacting Bose® customer service.

Media center serial number: \_\_\_\_\_

Acoustimass module serial number: \_\_\_\_\_

Dealer name: \_\_\_\_\_

Dealer phone: \_\_\_\_\_ Purchase date: \_\_\_\_\_

We suggest you keep your sales receipt and product registration together with this owner's guide.

## Unpacking

Carefully unpack your system. Save all packing materials, which provide the safest way to transport your system. Check to be sure your system includes the parts shown in Figure 1.

If any part of the system appears damaged, do not attempt to use it. Notify Bose or your authorized Bose® dealer immediately. For Bose contact information, refer to the address sheet included in the carton.

**WARNING:** To avoid danger of suffocation, keep the plastic bags out of the reach of children.

**Figure 1**

Contents of the shipping carton

Your carton contains one of the cords below:

120V power cord



115/230V power cord with adapter



220V power cord

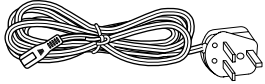

230V power cords



240V power cord

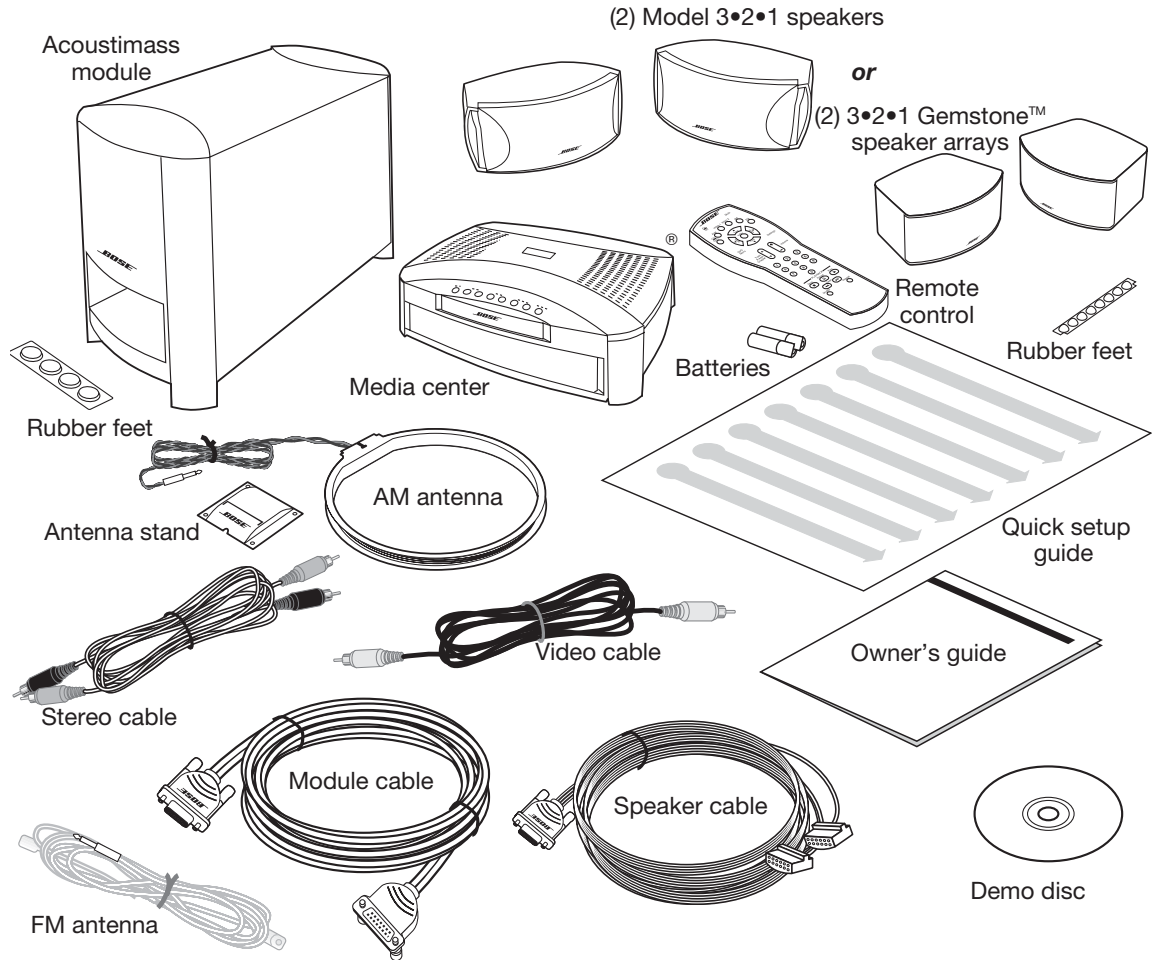

### Finding the product serial numbers

Now is a good time to find the serial numbers on the bottom of the media center and Acoustimass® module. Copy those numbers onto your product registration card and in the space provided on page 7.



## Selecting locations for your 3•2•1 home entertainment system components

Use the following guidelines to choose locations and positions for the components of your 3•2•1 home entertainment system. Keep in mind that all of the system components will be connected to the media center. The Acoustimass® module is the only part of the system that will connect to a power outlet.

♪ **Note:** While these guidelines are offered to provide the best system performance, you may find other placement choices that are more convenient and provide the sound you enjoy.

### Placing the media center

⚠ **CAUTION:** Do not block any ventilation openings. For reliable operation of the product and to protect it from overheating, put the product in a position and location that will not interfere with its proper ventilation. For example, do not place the product on a bed, sofa, or similar surface that may block the ventilation openings. Do not put it in a built-in system, such as a bookcase or cabinet that may keep air from flowing through its ventilation openings.

- Place the media center where nothing obstructs opening the disc tray on its front panel.
- Make sure the media center will be placed close enough to the Acoustimass module and the speakers so that all the cables will reach.
- Make sure the media center will be placed close enough to additional source components (TV, tape player, VCR) so that all the cables will reach.

### Placing the 3•2•1 speakers

Choosing a good location for the speakers will allow you to experience the audio surround effects that your 3•2•1 home entertainment system is designed to deliver.

Place the two speakers either on top of the TV or at equal distance to the left and right of the TV screen (Figure 2). Keep both speakers at approximately the same height.

♪ **Note:** The speakers are magnetically shielded to prevent interference when they are on or near the TV.

**Figure 2**

Placement of the media center and 3•2•1 or 3•2•1GS speakers in an entertainment unit

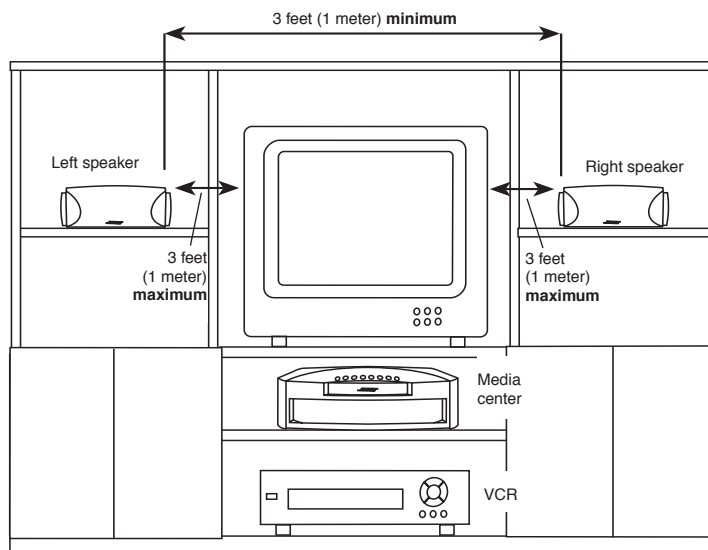

Place each speaker a **maximum of 3 feet (1 meter)** away from the edge of the **TV screen**. Placing the speakers more than 3 feet away from the TV can cause the sound to become separated from the picture.

If you are using a bookshelf or a home entertainment unit, place each speaker at the **front edge** of its shelf. Positioning the speakers too far back in an enclosed space can change the overall quality of sound and alter the movie sound effects.

The speakers must be placed at least **3 feet (1 meter)** apart from each other in order to optimize the surround sound experience.

**WARNING:** Choose a stable and level surface for both speakers. Vibration can cause the speakers to move, particularly on smooth surfaces like marble, glass, or highly polished wood. If you are placing the speakers on a flat surface, be sure to attach the smaller of the two sets of supplied rubber feet to the bottom surface. You may obtain additional rubber feet (part number 178321) from Bose® customer service. To contact Bose, refer to the list of offices included in the product carton.

Be sure each 3•2•1 or 3•2•1 GS speaker faces straight ahead toward the listening area. Do not place the speakers at an angle (Figure 3).

**Figure 3**

Recommended placement of the 3•2•1 and 3•2•1 GS speakers, facing straight ahead toward the listening area, not angled

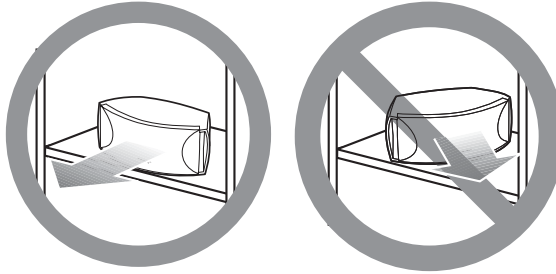

**Note:** Angling one or both speakers into or away from the listening area significantly alters system performance.

The 3•2•1 and 3•2•1 GS speakers are designed to sit only on their bottom surface, with the Bose logo right-side up (Figure 4).

**Figure 4**

Recommended orientation of the speakers, with Bose logo upright, not angled or upside down

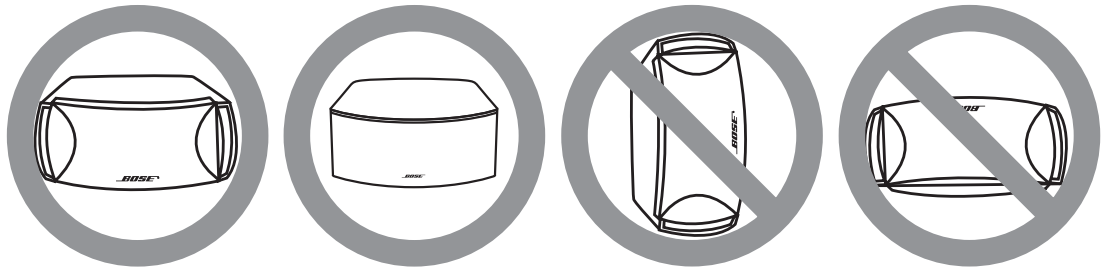

**Speaker Accessories**

The 3•2•1 and 3•2•1 GS speakers can also be mounted on optional Bose brackets, table stands, or floor stands (Figure 5). For ordering information, refer to “Accessories” on page 46.

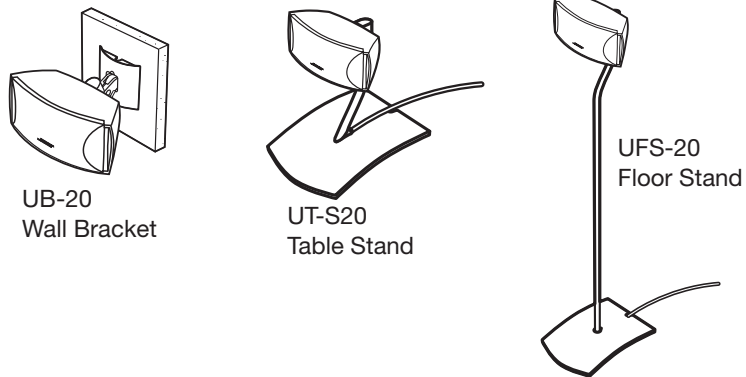
**Figure 5***Speaker accessories***Additional cables**

To contact Bose for additional or longer cables, refer to the list of offices included in the product carton.

## Placing the Acoustimass® module

Consider the guidelines below when choosing a location for the Acoustimass® module.

### Make sure to place it:

- within reach of the cables to the music center and an AC (mains) power outlet
- at the same end of the room as the TV and the speakers (Figure 6)
- a minimum of 3 feet (1 meter) from the TV, to prevent interference from the module, which is not magnetically shielded

**Figure 6**

3-foot distance between the Acoustimass module and the TV

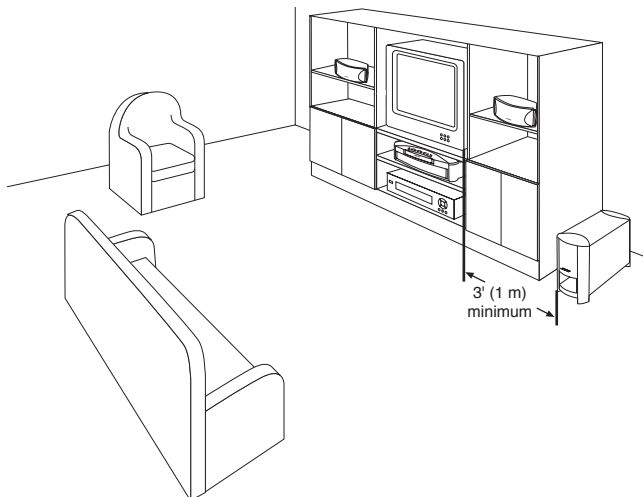

Attach the medium-sized rubber feet to the bottom of each foot on the module. The rubber feet provide increased stability and protection from scratches.

**CAUTION:** The Acoustimass module generates a magnetic field. Although this is not an immediate risk to your video tapes, audio tapes, and other magnetic media, you should not store any of these items directly on or near the module.

### Keep the port and ventilation openings free and unimpeded:

- Choose a location that is convenient (under a table, behind a sofa or chair, screened by drapes) but will not block the ventilation openings of the module.
- Aim the port of the module into the room or along the wall. This prevents a blocked port or over-powering bass.
- Stand the Acoustimass module on its feet. Do not lay it on its side or stand it on either end (Figure 7).

**Figure 7**

Recommended orientation for the module

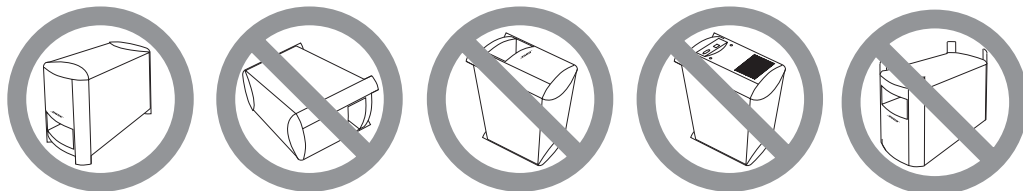

**CAUTION:** Do not block the openings on the back of the module, which provide ventilation for the built-in circuitry.

**When the system setup is completed**

With the speakers and media center placed as directed, you can enjoy the freedom to sit, recline, or move about in the room without missing a note.

**Figure 8**

System placement for ideal coverage

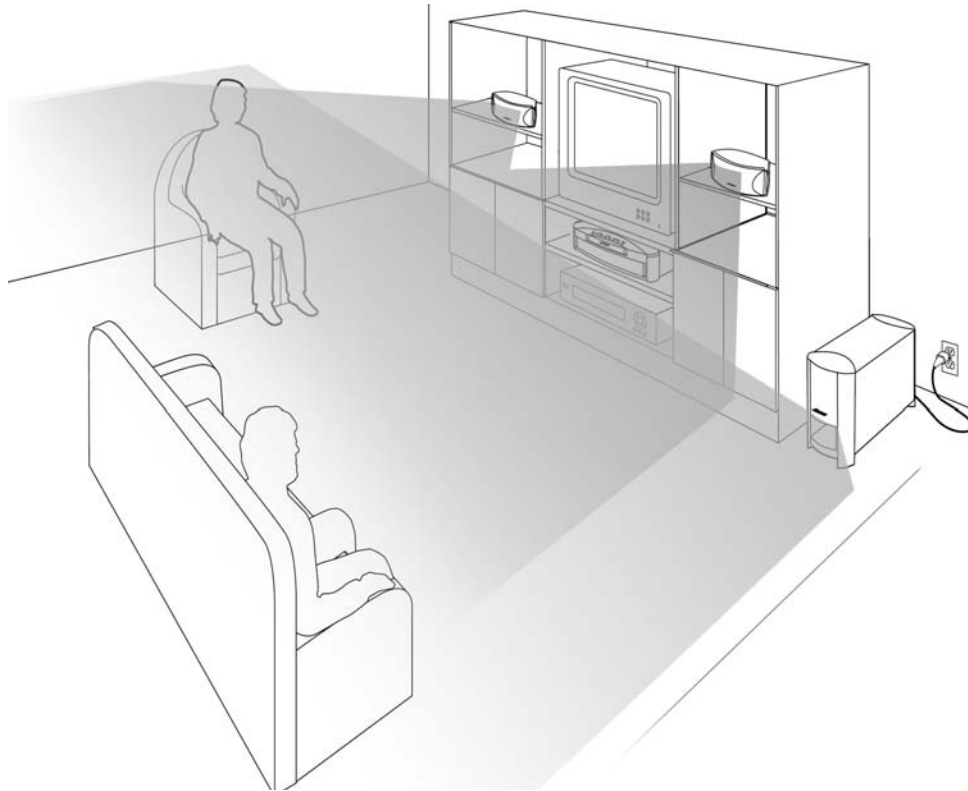

**CAUTION:** Be sure to read the section on making the connections before you plug in the system.

## Making the connections

The components of the 3•2•1 and 3•2•1 GS home entertainment systems are connected through the media center, using custom cables supplied with the system. The jacks on the rear of the media center are labeled (Figure 9), to help get everything hooked up right the first time.

**Figure 9**

Connection panel on the rear of the media center

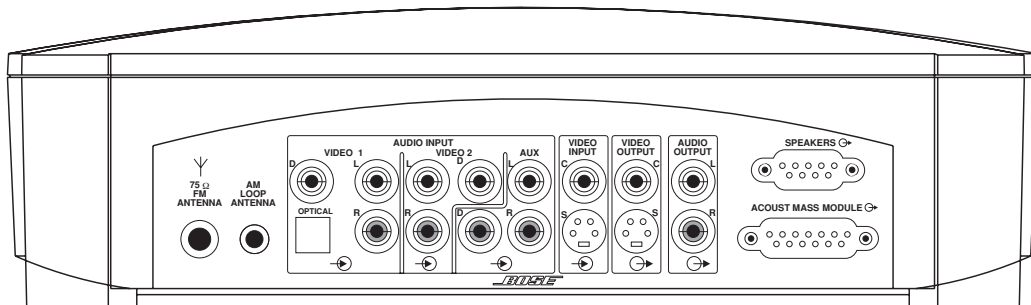

**CAUTION:** Do not plug the music system into an AC power (mains) outlet until all the components are connected.

### Additional cables

If additional audio cables or longer cables are needed to make these connections, contact Bose. Before you call, refer to the list of offices included in the product carton.

## Connecting the 3•2•1 speakers

1. Insert the single-plug end of the speaker cable into the SPEAKERS connector on the rear panel of the media center (Figure 10). Tighten the screws on either side of the plug.

**Figure 10**

Connecting the speaker cable to the media center

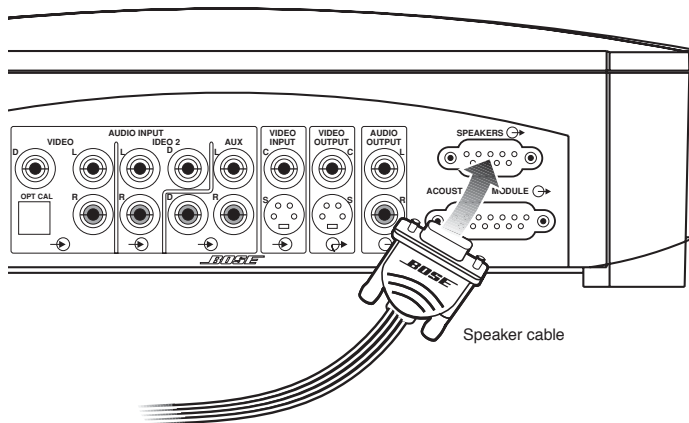

2. Grasp the two connectors at the other end of the speaker cable and pull the two strands of cable apart as much as necessary to reach each speaker (Figure 11).

**Figure 11**

Pulling apart the left and right strands of speaker cable

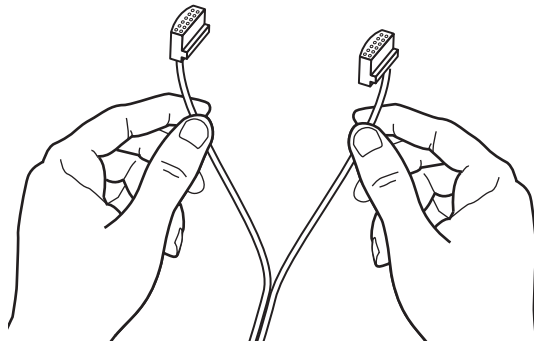

3. Plug the connector labeled LEFT into the jack on the rear of the left speaker (Figure 12).
4. Plug the connector labeled RIGHT into the rear jack on the right speaker.

**Figure 12**

Making the left and right speaker connections

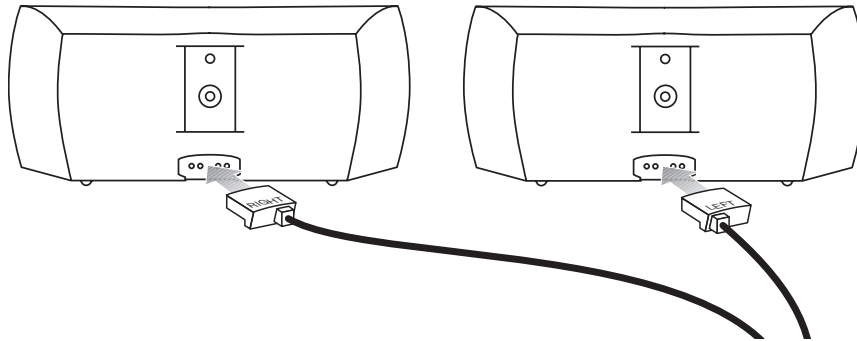

**Note:** When properly inserted, there will be a small gap between the plug and the speaker panel.

**Left and right speaker placement**

For optimal audio surround effects, be sure to place the LEFT speaker to the left of the TV as you face it. Place the right speaker to the right of the TV as you face it (Figure 13).

**Figure 13**

Left and right speaker placement

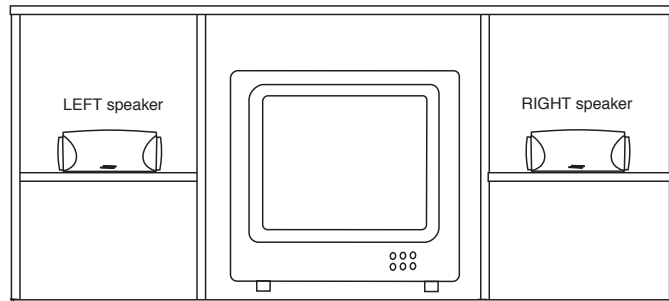

**Connecting the Acoustimass® module**

1. Locate the jack labeled MEDIA CENTER on the rear of the Acoustimass® module. Insert the right-angle connector (Figure 14) of the module cable into the MEDIA CENTER jack.
2. Locate the jack labeled ACOUSTIMASS MODULE on the rear panel of the media center. Insert the other end of the module cable into the ACOUSTIMASS MODULE jack.
3. Firmly tighten the two screws at each end of the module cable.

**Figure 14**

Connecting the Acoustimass module to the media center

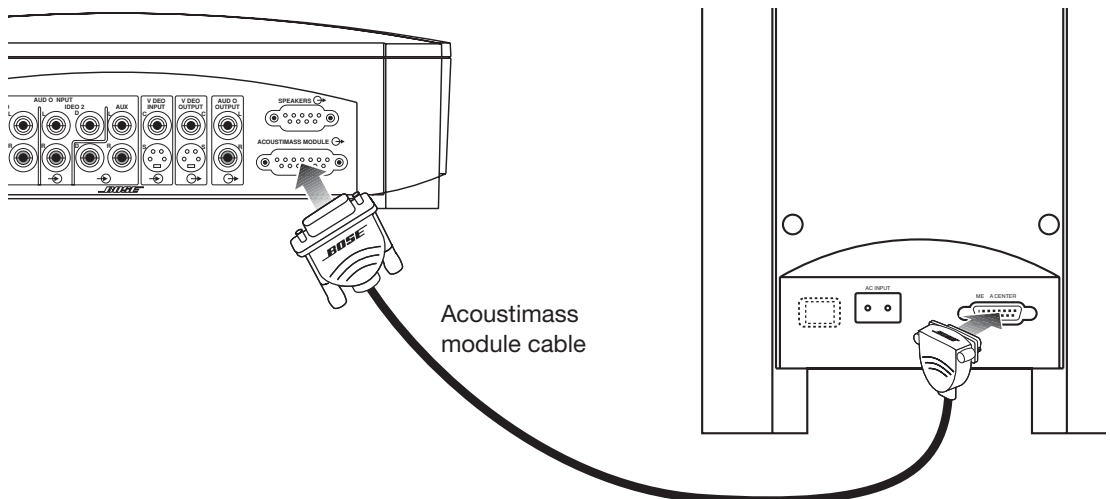

**WARNING:** Do not plug the Acoustimass module's power cord into the wall outlet until all other system connections have been made.

## Attaching the supplied antennas

On the rear panel of the media center there are jacks for AM and FM antennas (Figure 15). Unwind the wires for each antenna to provide the best reception.

- ♪ **Note:** An outdoor antenna may be used in place of the two that are supplied. To add an outdoor antenna, consult a qualified installer. Follow all safety instructions supplied with the antenna.

**Figure 15**

Adding the AM and FM antennas

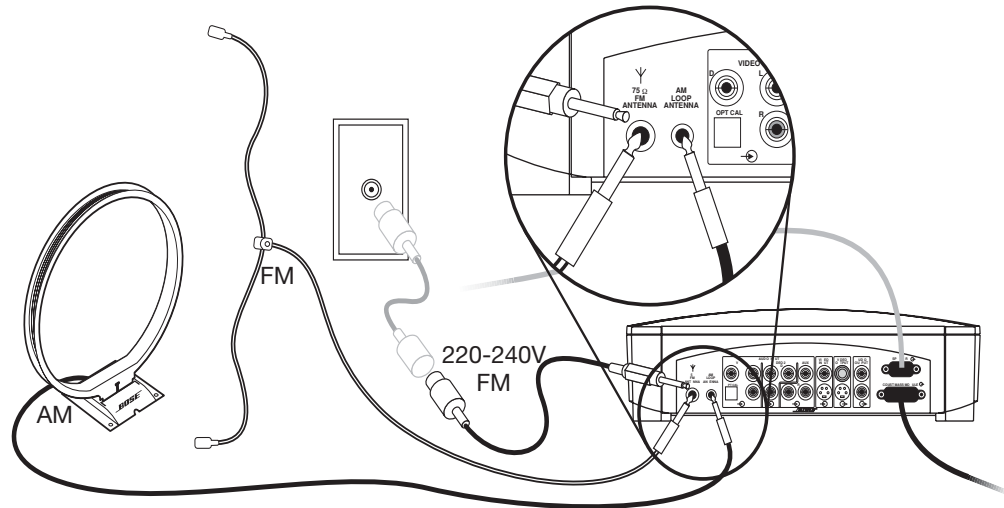

### FM antenna

Plug the connector into the FM antenna jack on the media center rear panel. Spread out the antenna arms at the other end and move them around to establish optimum FM reception. Extend the antenna as far from the media center and other external equipment as possible.

### AM antenna

1. Plug the connector into the AM antenna jack on the media center.
2. Move the antenna loop as far as possible, at least 20 inches (50 centimeters) from the media center and at least 4 feet (1.2 meters) from the Acoustimass® module. Experiment with positioning the loop for optimum AM reception.
3. Follow the instructions enclosed with the AM loop antenna to stand it on the supplied base, or mount it to a wall.

### Connecting cable FM radio

Some cable TV providers make FM radio signals available through the cable service to your home. This connection is made to the external FM jack on the back panel of the media center. To connect to this service, contact your cable TV provider for assistance.

- ♪ **Note:** Make sure that the cable radio installation includes a TV/FM splitter so that only the FM radio band, not the cable TV band, is received by the media center. If necessary, contact your cable company.



## Connecting your TV to the media center

- ♪ **Note:** If you will be using the 3•2•1 home entertainment system with both a TV and a VCR, skip this section and go to “Connecting your TV and VCR to the media center” on page 19.
- ♪ **Note:** If your TV does not have an audio output jack, see “If your TV does not have audio output jacks” on page 21.

1. Attach one end of the supplied video cable (yellow) to the VIDEO OUTPUT jack on the back of the media center (Figure 16).
2. Attach the other end of the video cable (yellow) into one of the video input jacks on your TV.

### Make note of the video input jack you use

Most TVs have several video input jacks (for example: Video 1, Input 1, or Aux).

When you connect the yellow video cable to one of these jacks, make note of the name of the jack you choose. You will need to select the corresponding video input setting on your TV in order to play a DVD. See “Selecting the correct video input on your TV” below.

3. Locate the AUDIO INPUT jacks on the back of the media center. Under the AUDIO INPUT heading, there are jacks labeled VIDEO 1, VIDEO 2, and AUX.
4. Attach the supplied stereo cable to the media center by inserting the white plug into the jack labeled VIDEO 1 (L), and the red plug into the jack labeled VIDEO 1 (R).
5. Attach the other end of the stereo cable to the TV by inserting the white plug into the AUDIO OUTPUT (L) jack, and the red plug into the AUDIO OUTPUT (R) jack.

**Figure 16**

Connecting your TV to the media center

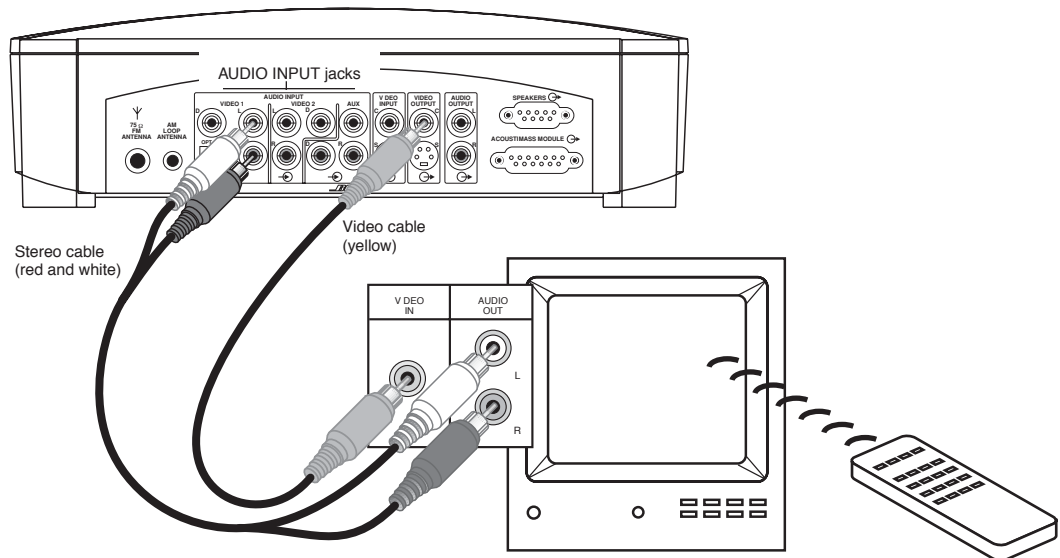

### Selecting the correct video input on your TV

In order to play a DVD, your television must be set to receive signals from the correct video input jack.

Most TVs have a TV/VIDEO, INPUT, or AUX IN button for selecting the video input. When the TV is on, the display “VIDEO 1”, “VIDEO 2”, or “AUX” will usually appear in a corner of the screen to indicate which video input is currently selected.

Before playing a DVD, locate the name of the video input jack (on the TV) that you have connected the yellow video cable to, then turn the TV on and select the video input (on the screen) that matches the name of that jack. If you are unable to select the correct video input setting on your television, please consult your TV’s owner’s guide.

**S-video as an alternate means to connect to the TV**

An S-video input jack, provided on many TVs, delivers a higher-quality TV picture than the composite video output connection shown in Figure 16 on page 17.

To make this alternate connection, insert the end of an S-video cable from the TV into the S-VIDEO OUTPUT on the media center. This cable may be purchased from your Bose® dealer or a local electronics retailer.

- ♪ **Note:** *Some older TVs with standard TV cable connectors do not have a composite video or an S-video input. Such TVs are not compatible with any DVD players and require use of an RF modulator for this connection, which is available at your local electronics store.*
- ♪ **Note:** *If you use S-video to connect your cable box to the media center, you must also use S-video to connect all other components (such as the TV and VCR) to the system.*

**Turning off the internal speakers in your TV**

When you listen to TV audio through your 3•2•1 home entertainment system, the speakers in your TV should not be on. Use the on-screen menu on your TV to locate the setting for INTERNAL SPEAKERS and select OFF. (Refer to your TV owner's guide for instructions).

- ♪ **Note:** *In some models, when the TV's internal speakers are turned off, you may need to turn up the TV's volume by 75% to 100% in order to hear audio from the 3•2•1 home entertainment system. (See your TV owner's guide for details.)*

If your TV does not have an option to turn off the internal speakers, reduce the volume on your TV to its lowest setting.

## Connecting your TV and VCR to the media center

There are two options for connecting your TV and VCR to the media center. Before you proceed, you must determine if your TV has audio output jacks. Consult your TV owner's guide if you need assistance.

### If your TV has audio output jacks

If your TV has audio output jacks, you can directly route the TV audio to the 3•2•1 home entertainment system.

1. Attach one end of the supplied video cable (yellow) to the VIDEO OUTPUT jack on the back of the media center (Figure 17).
2. Attach the other end of the video cable (yellow) into one of the video input jacks on your TV.

### Make note of the video input jack you use

Most TVs have several video input jacks (for example: Video 1, Input 1, or Aux).

When you connect the yellow video cable to one of these jacks, make note of the name of the jack you choose. You will need to select the corresponding video input setting on your TV in order to play a DVD. See "Selecting the correct video input on your TV" on page 20.

3. Locate the AUDIO INPUT jacks on the back of the media center. Under the AUDIO INPUT heading, there are jacks labeled VIDEO 1, VIDEO 2, and AUX.
4. Attach the supplied stereo cable to the media center by inserting the white plug into the jack labeled VIDEO 1 (L) and the red plug into the jack labeled VIDEO 1 (R).
5. Attach the other end of the stereo cable to the TV by inserting the white plug into the Audio Out (L) jack and the red plug into the Audio Out (R) jack.

**Figure 17**

Connecting your TV and VCR to the media center using the TV's audio output

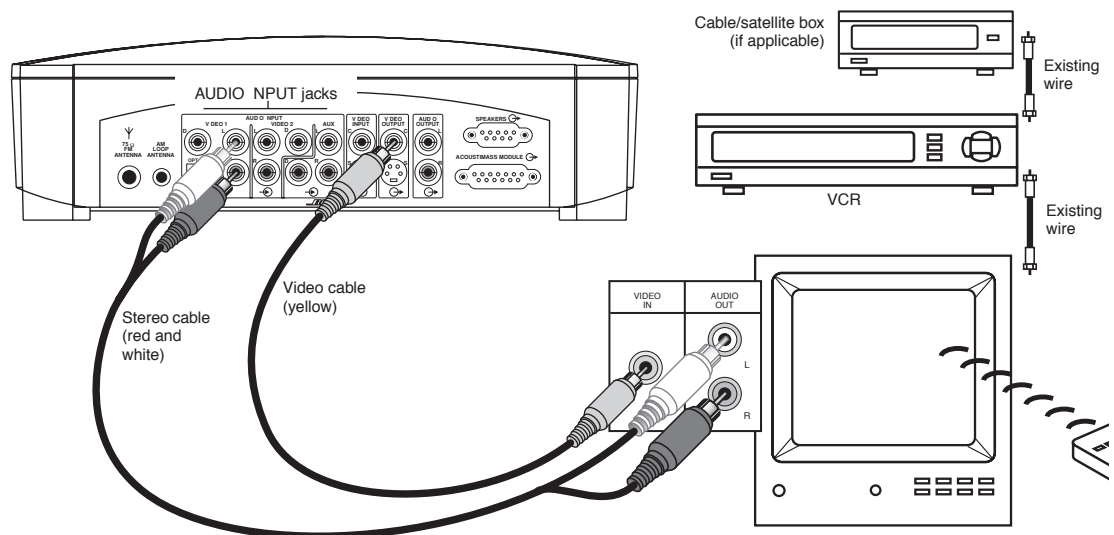

### **Selecting the correct video input on your TV**

In order to play a DVD, your television must be set to receive signals from the correct video input jack.

Most TVs have a TV/VIDEO, INPUT, or AUX IN button for selecting the video input. When the TV is on, the words "VIDEO 1", "VIDEO 2", or "AUX" will usually appear in a corner of the screen to indicate which video input is currently selected.

Before playing a DVD, locate the name of the video input jack (on the TV) that you have connected the yellow video cable to, then turn the TV on and select the video input (on the screen) that matches the name of that jack. If you are unable to locate the video input setting on your television, please consult your TV owner's guide.

### **Turning off the internal speakers in your TV**

When you listen to TV audio through your 3•2•1 home entertainment system, the speakers in your TV should not be on. Use the on-screen menu on your TV to locate the setting for INTERNAL SPEAKERS and select OFF. (Refer to your TV owner's guide for instructions).

 **Note:** *In some models, when the TV's internal speakers are turned off, you may need to turn up the TV's volume setting by 75% to 100% in order to hear audio from the 3•2•1 home entertainment system. (See your TV owner's guide for details.)*

If your TV does not have an option to turn off the internal speakers, you may need to adjust both the 3•2•1 system volume and your TV volume until you find a level that produces the desired sound.

### If your TV does not have audio output jacks

If your TV does not have audio output jacks, you will need to import audio to the 3•2•1 home entertainment system through a secondary source, such as a VCR. For this type of connection, you will need one additional video cable, which can be purchased at your local electronics store.

1. Attach one end of the supplied video cable (yellow) into the Video Output jack on your VCR.
2. Attach the other end of the supplied video cable (yellow) to the VIDEO INPUT jack on the back of the media center.
3. Locate the AUDIO INPUT jacks on the back of the media center. Under the AUDIO INPUT heading, there are jacks labeled VIDEO 1, VIDEO 2 and AUX.
4. Attach the stereo cable to the media center by inserting the white plug into the jack labeled VIDEO 1(L) and the red plug into the jack labeled VIDEO 1(R).
5. Attach the other end of the stereo cable to the VCR by inserting the white plug into the Audio Out (L) jack and the red plug into the Audio Out (R) jack.
6. Attach a second video cable to the VIDEO OUTPUT of the media center and the Video Input jack on your TV.

### Make note of the video input jack you use

Most TVs have several video input jacks (for example: Video 1, Input 1, or Aux). When you connect the yellow video cable to one of these jacks, make note of the name of the jack you choose. You will need to select the corresponding video input setting on your TV in order to play a DVD. See “Selecting the correct video input on your TV” on page 22.

**Figure 18**

Connecting your TV and VCR to the media center with no TV audio output

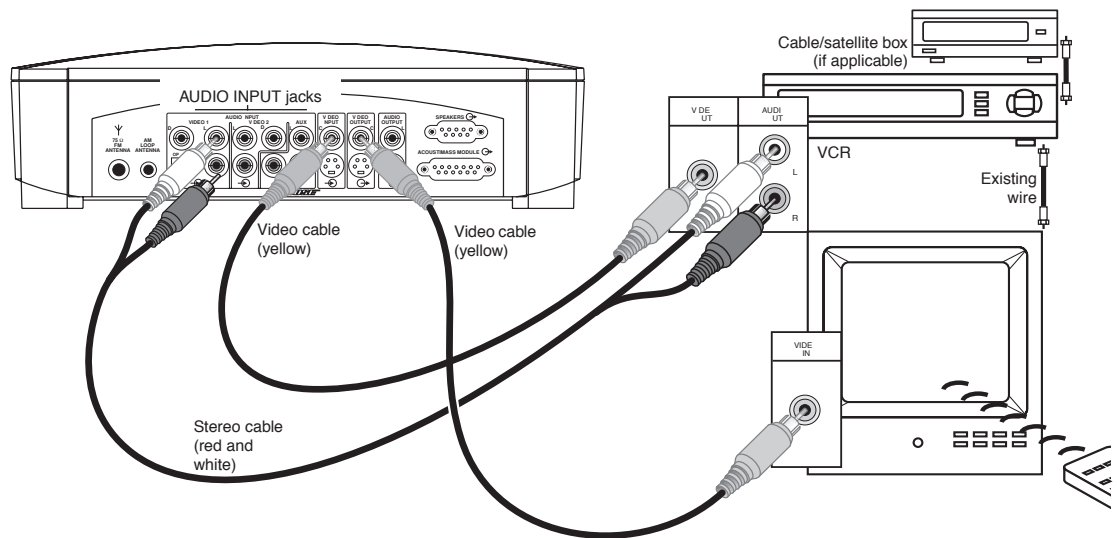

**Selecting the correct video input on your TV**

In order to play a DVD, your television must be set to receive signals from the correct video input jack.

Most TVs have a TV/VIDEO, INPUT, or AUX IN button for selecting the video input. When the TV is on, the words "VIDEO 1", "VIDEO 2", or "AUX" will usually appear in a corner of the screen to indicate which video input is currently selected.

Before playing a DVD, locate the name of the Video Input jack (on the TV) that you have connected the video cable to, then turn the TV on and select the video input (on the screen) that matches the name of that jack. If you are unable to locate the video input setting on your television, please consult your TV owner's guide.

- ♪ **Note:** Some combination TV/VCR units may not work with the Bose 3•2•1 and 3•2•1 GS home entertainment systems. Please refer to your TV/VCR owner's manual for information.
- ♪ **Note:** A stereo or Hi-Fi VCR is required for optimal sound performance. If your VCR only has one audio output and is not labeled Stereo or Hi-fi, you have a mono VCR and require a Y-adaptor cable (available at electronics stores) to connect audio to the media center. Then select Mono decoding (see "Audio Setup menu" on page 40) so your TV will simulate surround sound effects. Otherwise you will hear mono sound from both speakers.

**Making the final power connection**

- ⚠ **CAUTION:** For dual voltage models only, be sure to set the dual voltage switch on the back of the Acoustimass® module to the appropriate voltage for your area (115V or 230V) before connecting to power. If you are not sure about the proper voltage for your area, consult your local electrical authorities.

To make the final connection, insert the small connector end of the power cord into the AC INPUT jack on the module. Insert the large end of the cord into an AC power (mains) outlet (Figure 19).

**Figure 19**

Connecting the power cord

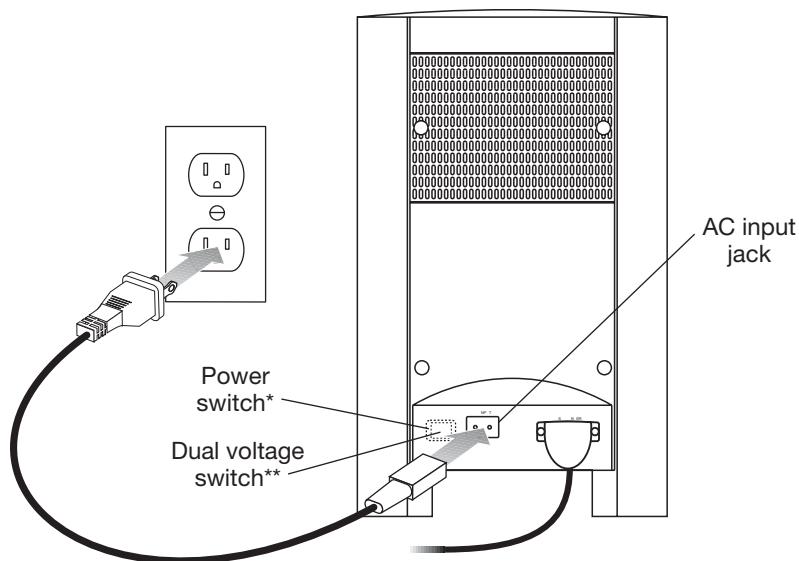

\*On 220-240V models only; \*\* On 115/230V dual voltage models only

- ♪ **Note:** On 220-240V models only, turn the Acoustimass module POWER switch to on (I).

## Installing remote control batteries

1. On the back of the remote, slide open the battery compartment (Figure 20).
2. Insert the two supplied AA (IEC-R6) 1.5V batteries, or their equivalent, as shown. Match the plus (+) and minus (-) marked on the batteries with the plus (+) and minus (-) inside the battery compartment.
3. Slide the battery compartment cover back into place.

**Note:** Replace the batteries when the remote control stops operating or its range seems reduced.

**Figure 20**

Installing the batteries

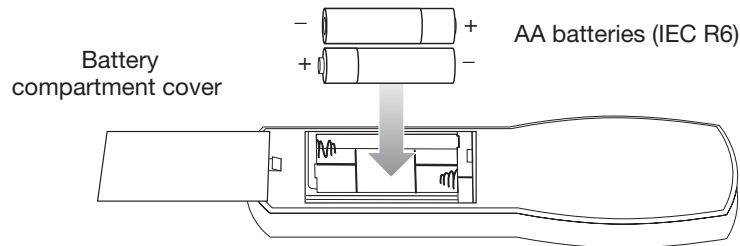

## Connecting other sources

The 3•2•1 home entertainment system is designed to deliver high-quality home entertainment free of complexity and complications. But it also provides flexibility for you to add other components in a variety of configurations.

If you plan to use your 3•2•1 home entertainment system with other components, please read and consider the important guidelines below.

### Guidelines for connecting other components

- You can connect the audio output of up to three components, including your TV, directly to the media center using the VIDEO 1, VIDEO 2, and AUX input jacks on the rear panel.
- Each input includes jacks for Left and Right analog audio and a coaxial jack for digital audio. In addition, the VIDEO 1 input provides an optical jack for digital audio.
- The jacks marked VIDEO 1 and VIDEO 2 are set automatically for movie EQ. If you connect a video source to AUX, you can still set sound for movie EQ in the Settings on-screen menu.
- When connecting a component's audio to the media center jacks, remember to:
  - use standard RCA audio cables
  - match the red connector to the right channel (R) and the white (or black) connector to the left channel (L)
- For further details on making the video connections between your VCR and TV, refer to the manuals for those video components.

**Note:** The recommendations contained in this owner's guide are basic suggestions for connecting external devices to our system. Instructions and terminology pertinent to these external devices may vary, depending on the manufacturer. Consult the external device's original owner's guide for clarification on its setup and usage prior to making any connection.

**Figure 21**

Advanced analog and digital connections, using S-video pass-through to the media center

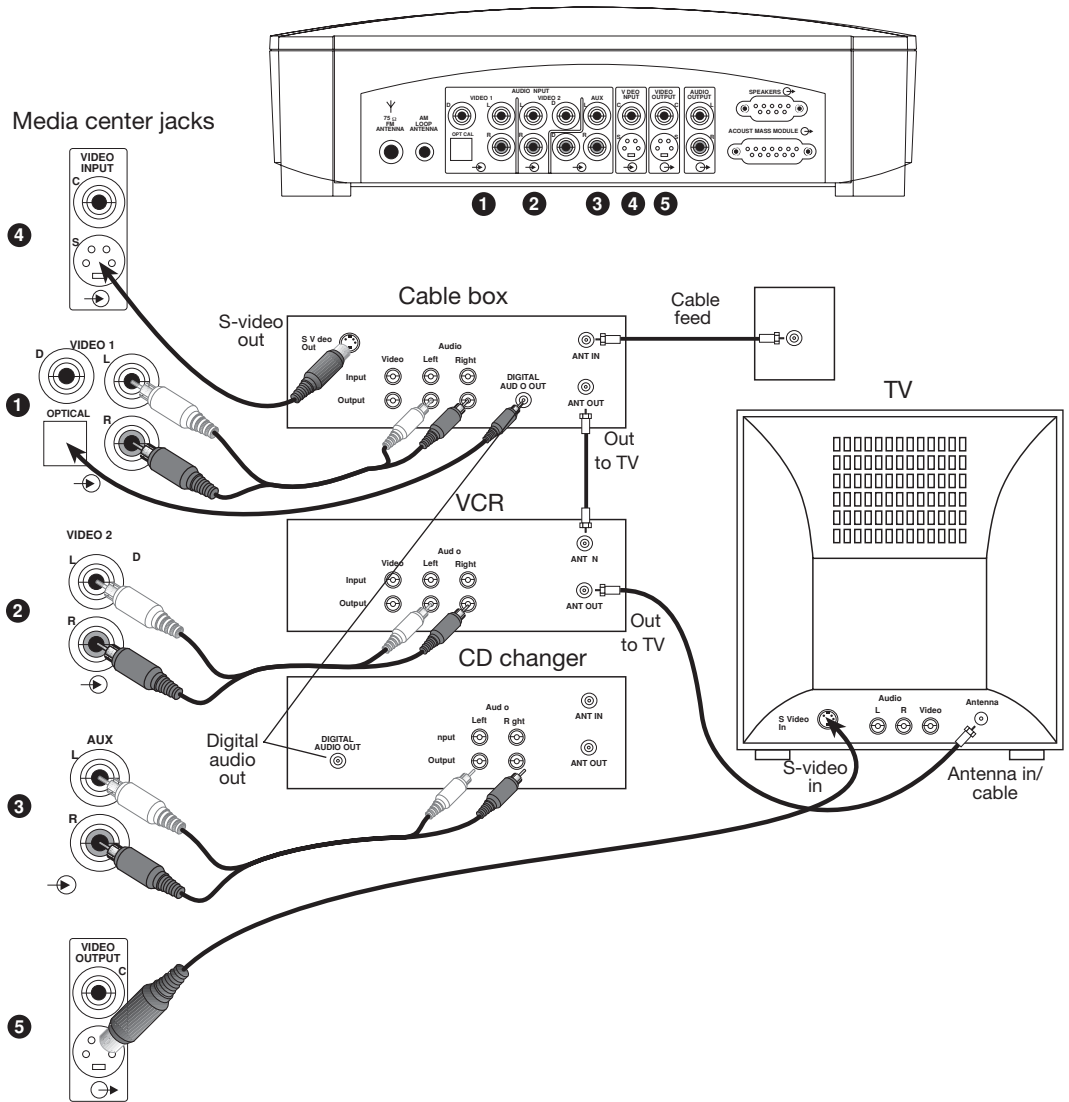



### Connecting recording equipment

The rear panel of the media center provides audio output (RECORD) connections for audio recording devices such as a cassette deck (Figure 22).

**Figure 22**

AUX input connections

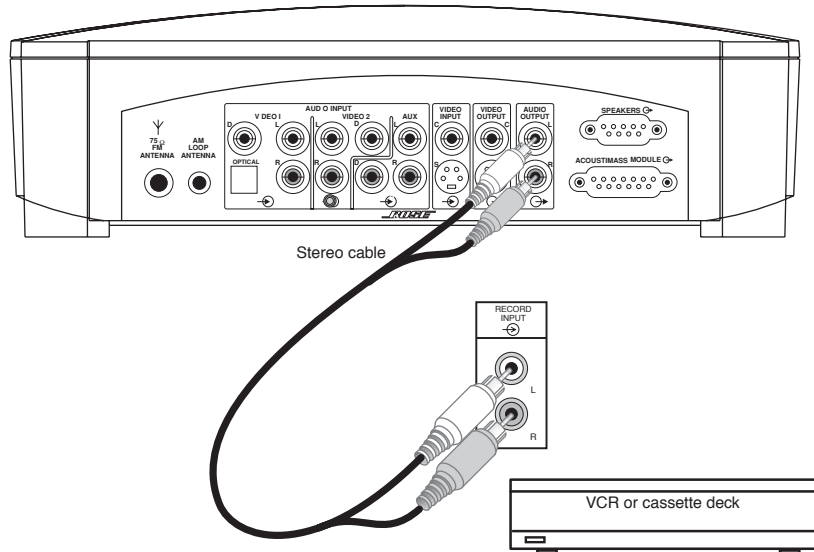

### Connecting other playback equipment

Other playback components, such as an audio CD changer, can be connected to the AUX inputs on the rear panel of the media center (Figure 22).

**Figure 23**

AUX input connections

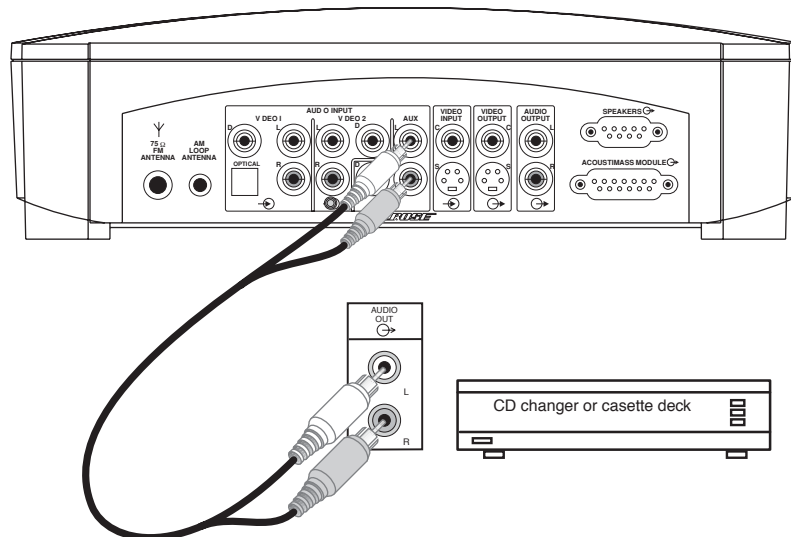

### Connecting digital audio components

Your other audio components may feature a digital audio output. If so, you can connect an optical output to the OPTICAL jack of the VIDEO 1 INPUT or a coaxial output to the coaxial jacks of VIDEO 1, VIDEO 2, or AUX on the rear panel of the media center. Use an optical digital cable or coaxial cable to make these connections.

**Note:** The digital audio inputs of this system are not able to decode a DTS bitstream from an external component.

## Turning on the system

You can turn your system on and off by pressing the **On/Off** button on the remote or the **Power** button on top of the media center. Or, you can press any source button on the remote to select the source and turn the system on at the same time.

If you followed the instructions in the Setup section of this guide, you can turn on the media center by simply pressing the **Video 1** button on your remote.

To turn on a component connected to the media center, use the remote or power switch for that specific component, or the advanced remote supplied with the 3•2•1 GS system.

**Note:** The basic 3•2•1 remote and media center cannot switch components, such as the TV or VCR, on or off. However, the advanced remote supplied with the 3•2•1 GS system can be "taught" to do so. For additional information about the advanced remote, see "The advanced remote control" on page 28.

## The remote control

**Note:** The basic functions of the advanced remote are the same as the 3•2•1 remote described below.

Buttons on the remote control are grouped according to function. Other buttons on the media center provide some of the same controls described below.

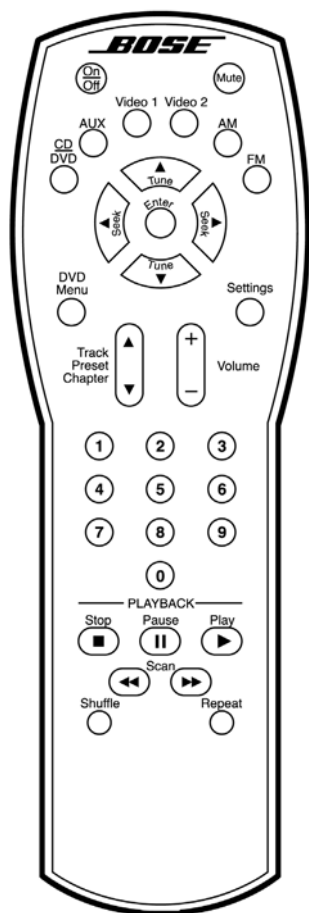

### POWER and MUTE controls



Switches the system on or off.



Mutes/unmutes the system volume.

### SOURCE controls



Selects the built-in CD/DVD player and turns the system on. Unmutes the system volume.



Selects AUX as the sound source and turns the system on. Unmutes the system volume.



Selects Video 1 as the sound source and turns the system on. Unmutes the system volume.



Selects Video 2 as the sound source and turns the system on. Unmutes the system volume.



Selects the built-in tuner and turns the system on to the previously selected AM station. Unmutes the system volume.



Selects the built-in tuner and turns the system on to the previously selected FM station. Unmutes the system volume.

**SOURCE and MENU controls**

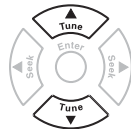
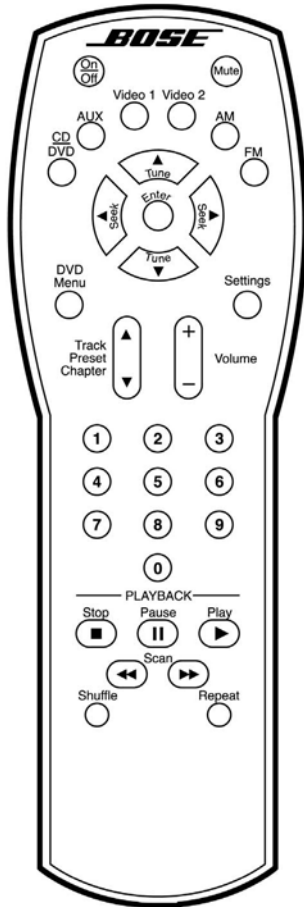

Tunes the AM/FM radio up/down to the next higher/lower frequency.

In an on-screen menu, selects the next item, up or down.

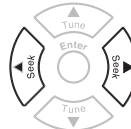

Seeks forward/backward to the next strongest radio station.

In an on-screen menu, changes the setting of a selected menu item.

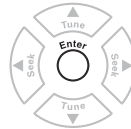

Enters submenus. Also submits custom settings, choices, or entries in conjunction with other buttons.



Displays the menu of the DVD disc currently loaded in the tray, as the particular DVD allows.



Displays or exits the Bose 3•2•1 system on-screen menus, provided that the correct Video Input setting is selected on the TV. See “Selecting the correct video input on your TV” on page 17.



Skips to the next/previous DVD chapter, radio station preset, or CD track.



Raises or lowers the system volume.

+ Unmutes the system volume. Raises the volume.

– Lowers the system volume while it is muted.

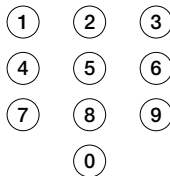

Each button gives you access to a similarly numbered DVD chapter, CD track, or radio station preset.

When selecting numbers 1 through 9, entering a zero before the number ensures the fastest response.

**PLAYBACK controls**



Stops the disc player and, *for DVDs only*, temporarily holds the place where the disc stopped. Press **Stop** again and the player moves to the beginning of the disc.



Pauses the disc player in place. After 20 minutes, switches to Stop.



Starts the disc player.



Scans back or forward for DVD chapters, CD tracks, or the next strongest radio station.



Plays audio CD tracks (not DVD chapters) in varied order. Press again to cancel this mode.



Repeats a CD, CD track, DVD chapter, or DVD title until the button is pressed again.

## The advanced remote control *(Supplied with the 3•2•1 GS system or the 3•2•1 system in Europe only)*







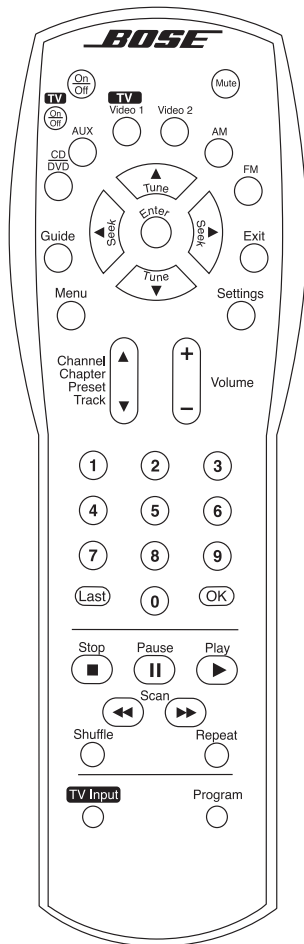

If you purchased the 3•2•1 GS system, your system came with the advanced remote control which can be programmed to control your TV and/or cable/satellite box. To contact Bose for information on how to purchase the remote separately, refer to the address sheet included with the system.

**Note:** *This remote functions as described on pages 26 and 27, with some additional features.*

Menu buttons, described on the previous page, work similarly with the cable/satellite guide menu on your TV. However, the volume button on this remote does not affect the TV volume.

### Enhanced controls



-  Switches the TV on or off.
-  Does not turn cable box or satellite box on or off.
-  Selects TV as the source.
-  Turns on and off the cable/satellite guide menu.
-  Exits the cable/satellite box's displayed menu.
-  Returns to the TV or cable/satellite channel previously selected.
-  Enters the selected channel.
-  Changes the input selection on the TV.
-  Programs the advanced remote to control the TV and cable/satellite box.

### Programming the advanced remote

Find the four-digit setup code for your TV and cable/satellite box in the Appendix on page 48

**Note:** *More than one code may work with your particular brand product. If you notice a lack of response or limited functionality after programming the remote, try a different code.*

**Note:** *If your advanced remote flashes rapidly several times during programming, an error has occurred. Wait 7 seconds for the remote to clear and begin programming again.*

#### To control the TV

1. Turn on both the 3•2•1 system and your TV.
2. Press and hold the **Program** and **TV On/Off** buttons for 3 seconds. The remote Source buttons will light to signal that you have entered programming mode.
3. Enter your TV's four-digit setup code.
4. Press **Program** once to complete programming. The remote will flash once to indicate successful programming. To confirm that, use the remote to change TV channels.

#### To control the cable/satellite box

1. Turn on both the 3•2•1 system and your cable/satellite box.
2. Press and hold the **Program** and **Guide** buttons for 3 seconds. The remote source buttons will light to signal that you have entered programming mode.
3. Enter your cable/satellite box's four-digit setup code.
4. Press **Program** once to complete programming. The remote will flash once to indicate successful programming. To confirm that, use the remote to change cable channels.

## The media center

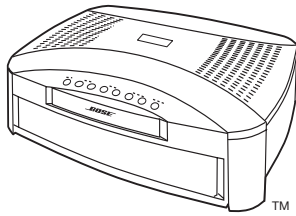

The media center has a control panel on the top, a display area on the front that indicates the current status of the system, and a DVD/CD tray that opens on the front of the console.

### Control panel and buttons

The media center has eight buttons located on the top control panel. Their functions are also available through use of the remote control.

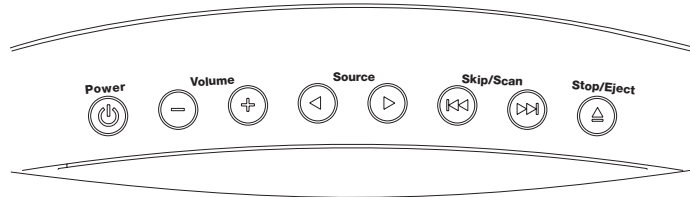

Turns the system on or off.



Raises/lowers the volume. Pressing + unmutes the system.



Moves from one source selection to the next.



Selects the previous/next DVD chapter or CD track or scans to previous/next strongest radio station.

In AM or FM mode: tap to seek a radio station; hold down to tune to a station.

In CD/DVD mode: tap to skip tracks or chapters; hold down to scan them.



Opens/closes the disc tray.

### Display indicators

With the system turned on, the music center display lights up to show the current system status. Not all of the possible choices shown below will light up at once (Figure 24). The display changes with each adjustment or selection you make.

**Figure 24**

All of the possible symbols that may appear, depending on the current status of the system

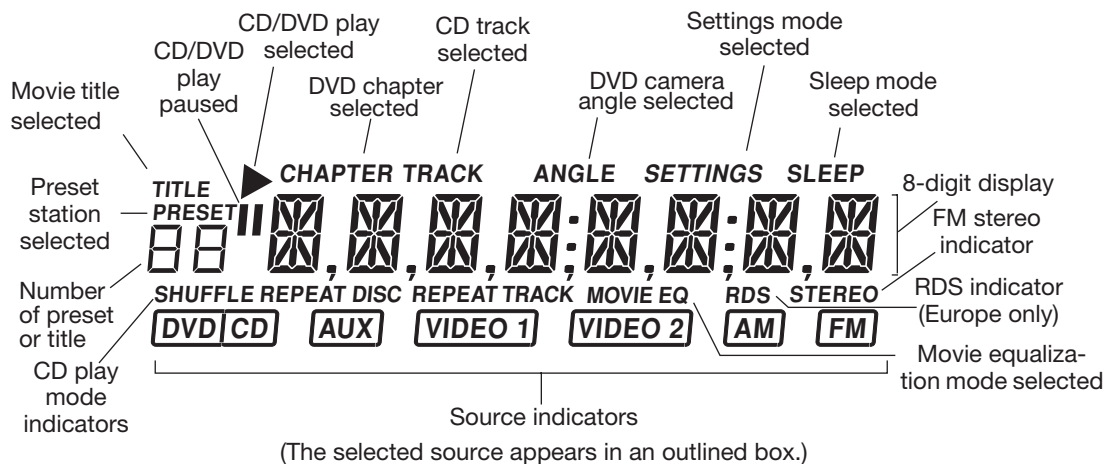

## TV on-screen menus

With both the TV and the 3•2•1 or 3•2•1 GS home entertainment system turned on, you can use menus that appear on the TV screen to choose among options for audio and video performance.

### To enter the Settings menu

Before you begin, make sure you have selected the correct Video Input setting on your TV. For more information, see “Selecting the correct video input on your TV” on page 17.

Make sure that the media center and the TV are both on. Press the **Settings** button on the remote. The displayed menu will contain items related to the currently selected source. For example, if you press **Settings** while watching a DVD, you will see a menu similar to the one in Figure 25.

### To leave the Settings menu

Press the **Settings** button again. The on-screen menu disappears.

**Figure 25**

Elements of the on-screen menu displays

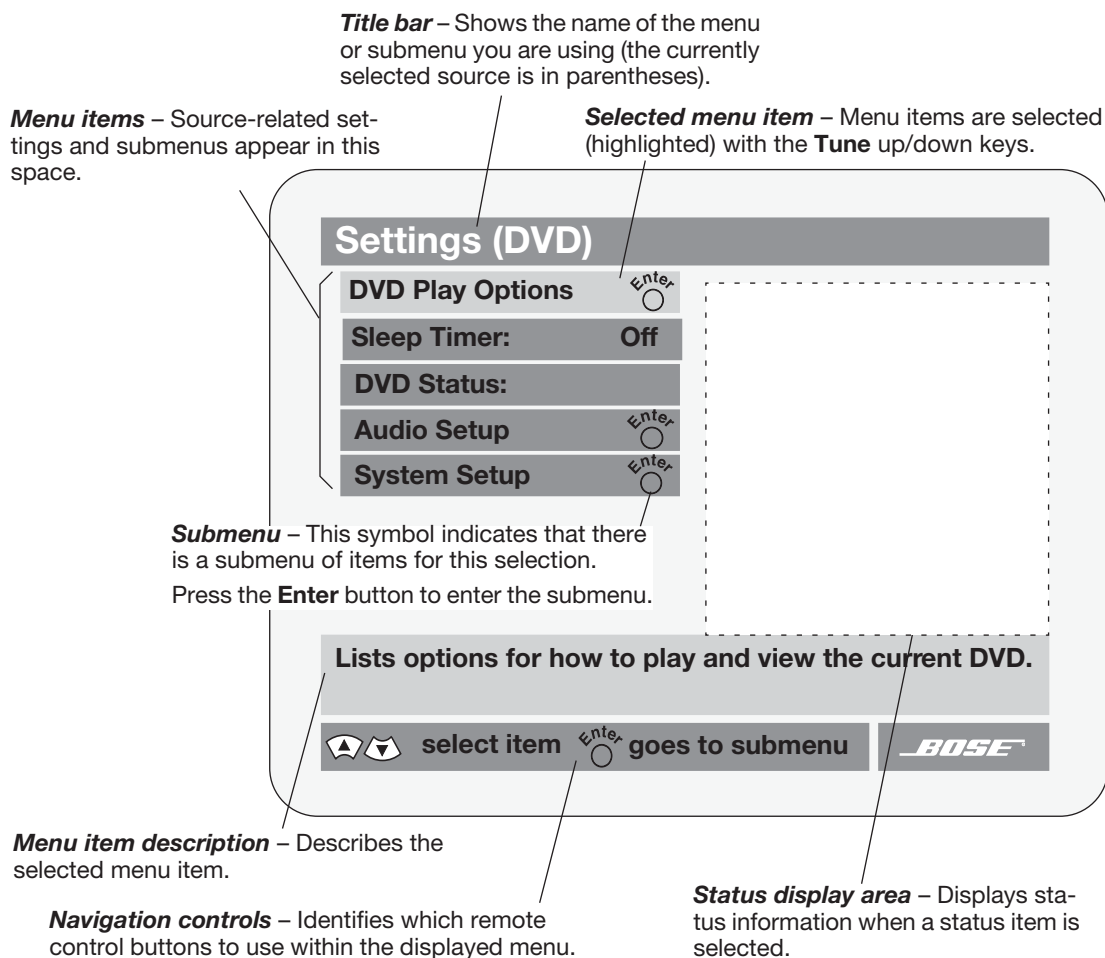

### To select a menu item

Use the remote control **Tune** ▲ or ▼, **Seek** ◀ or ▶, and **Enter**  buttons (as described on page 27) to move through these menus and make selections, as shown in Figure 25.

**To change a setting**

**Figure 26**

Example of changing a setting

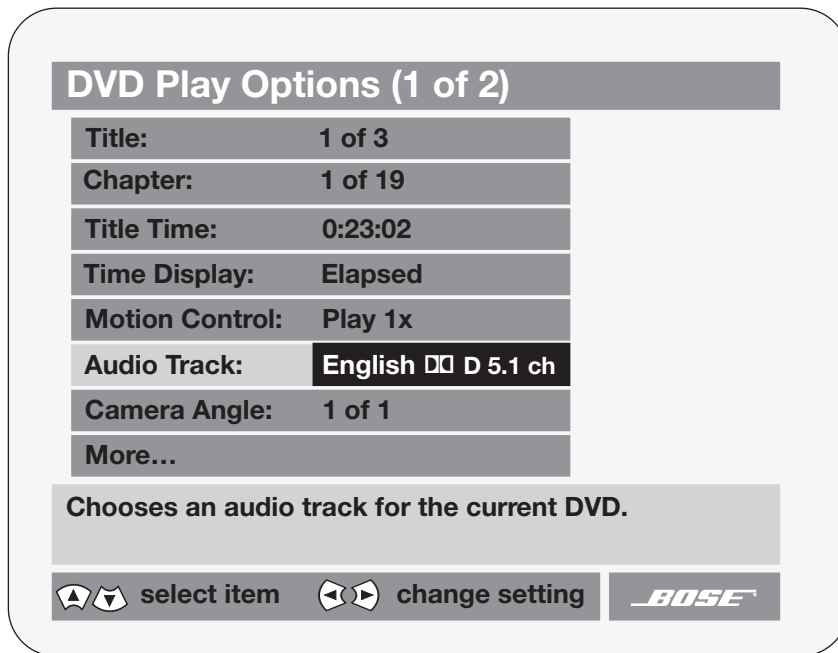



**To check the system status**

**Figure 27**

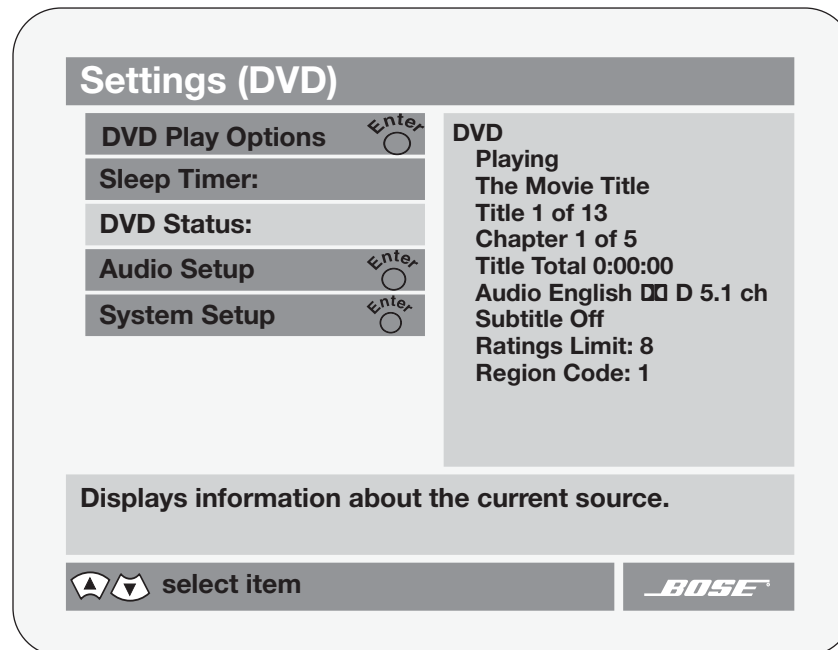
A DVD status example



## Turning your system on and off

You can turn your system on and off using the **On/Off** button () on the remote control or the power button () on top of the media center. When you turn it on with either button, the source that was played last is automatically selected.

You can also press any source button on the remote to turn the system on and select the source at the same time.

## Before you play your first DVD

Before you play the first DVD:

- Check the parental control settings (see “Using the Parental Control feature to restrict future play” on page 34).
- Familiarize yourself with the system remote control, as explained on page 26.
- Make sure that the region codes for the DVD player and disc match, as explained on page 5. Check the region code number on the media center label or on the shipping carton.
- Confirm that the disc is encoded for any required features. For example, in order to display subtitles in a movie, the disc must contain subtitle information.

### Selecting the correct video input on your TV



In order to play a DVD, your television must be set to receive signals from the correct video input jack.

Most TVs have a TV/VIDEO, INPUT, or AUX IN button for selecting the video input. When the TV is on, the word “VIDEO 1”, “VIDEO 2”, or “AUX” will usually appear in a corner of the screen to indicate which video input is currently selected.

Before playing a DVD, locate the name of the video input jack (on the TV) that you have connected the video cable to, then turn the TV on and select the video input (on the screen) that matches the name of that jack.

If you are unable to select the correct video input setting on your television, please consult your TV’s owner’s guide.

## Loading and playing a DVD

1. Turn your television on.
2. On the remote, press the **CD/DVD**  button to turn the media center on.
3. On the media center control panel, press the **Stop/Eject**  button.
4. Place the DVD in the open media center tray.
5. Press the **Stop/Eject**  button again to close the tray.

The DVD should begin to play automatically. If it does not, press **Play**  on the remote.



### Basic DVD operations

**If you want to:**

Pause a DVD movie...

Stop a DVD movie...

Skip to the next/previous chapter...

Repeat a chapter...

Search through the movie backward or forward...

Eject a DVD

**Use the remote to do this:**

Press **Pause** .

Press **Stop** .

Press **Chapter**  up/down.

Press **Repeat** while playing the chapter.

Press and hold **Scan**  or .

Press **Stop/Eject**  to stop the disc. Press again to eject.

**Using the Parental Control feature to restrict future play**

You can restrict the playing of DVD movies by using the Parental Control feature.

The 8 levels of parental control correspond with the ratings on DVDs, and are usually equivalent to standard movie ratings provided by the Motion Picture Association of America (MPAA). The levels of ratings range from 1 (unrestricted audiences) to 8 (most restricted). See DVD Rating chart below.

You can activate your parental control feature by storing a password in the system. Once you have set a level of parental control, DVDs rated above the level you have selected cannot be played. The parental control setting can be changed only with the use of a password.

For further instructions on how to access the control settings, see “Locating system settings” on page 42.

**Parental Control submenu**

The parental control submenu provides options for restricting access to certain DVDs.

<b>Selection:</b>	<b>Setting options:</b>	<b>What the setting affects:</b>
<b>Restrict Unrated Titles:</b>	On Off	Prevents viewing of unrated titles when password is set. Allows unrated titles to play.
<b>Change Password:</b>	----	Lists options for how to create a new password or to change a current password. Passwords cannot be deleted. If you forget your password, refer to “Troubleshooting” on page 45.
<b>Allowed Ratings:</b>	1 to 8*	Blocks access to DVDs rated higher than the limit. Rating 1 means only DVDs rated “General” can be viewed. Rating 8 means no parental controls are set and any DVD can be viewed.

<b>DVD Rating</b>	<b>General Description of Rating</b>	<b>MPAA Rating</b>
*8	Unrated (generally most restricted)	
7	Adult audiences	NC-17
6	Mature audiences	R
5	Mature teenage audiences	
4	Teenage audiences	PG-13
3	Mature young audiences	PG
2	Most audiences	
1	General (unrestricted audiences)	G

**DVD-specific behavior**

When you select features from any options menu while watching a movie, the movie may stop, skip forward, or skip back. This behavior is determined by the DVD you are playing and does not indicate a problem with the system.

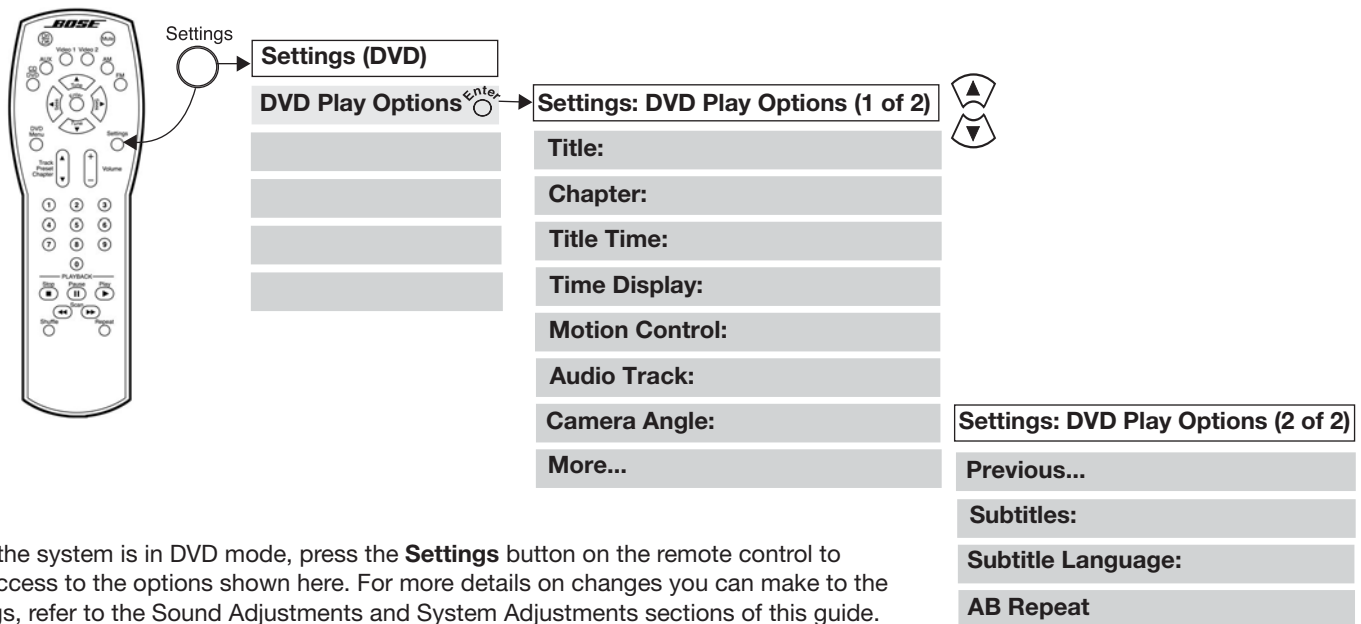

### DVD play options



While the system is in DVD mode, press the **Settings** button on the remote control to gain access to the options shown here. For more details on changes you can make to the settings, refer to the Sound Adjustments and System Adjustments sections of this guide.

Selection:	DVD setting options:	What the setting affects:
<b>Title:</b>	1 of n	Chooses the movie title through use of the number keys.
<b>Chapter:</b>	1 of n	Chooses the movie chapter through use of the number keys.
<b>Title Time:</b>	h:mm:ss	Moves to that time/place in the movie.
<b>Time Display:</b>	Elapsed	Shows how much time the movie has played in the on-screen DVD status and on the media center display.
	Remaining	Shows how much time the movie has left to play in the on-screen DVD status and on the media center display.
<b>Motion Control:</b>	<<Scan/ <<4x/ <<2x/ Pause/ Play1x/ 2x>>/ 4x>>/ Scan>>	Chooses forward or backward direction and speed for DVD playback.
<b>Audio Track:</b>	1 English <input type="checkbox"/> 5.1 ch 2 Lang2, 3 etc.	Chooses from the available soundtracks on the DVD. Additional soundtracks may contain different languages or alternate audio formats.
<b>Camera Angle:</b>	1 of max.	Chooses one of the available camera angles on the DVD.
<b>More...</b>	selection	Displays remaining menu items.
<b>Previous...</b>	selection	Displays initial menu items.
<b>Subtitle:</b>	On	Displays subtitles, if available, along the lower screen edge.
	Off	Hides subtitles. For use with Auto subtitles (refer to page 40).
<b>Subtitle Language:</b>	Lang1/ Lang2, etc.	Chooses one of the available languages for display of subtitles.
<b>AB Repeat</b>	selection	Repeats a specified section of a movie after prompting you to: <ul style="list-style-type: none"> <li>• Press <b>Enter</b> at the beginning of the section you want to repeat.</li> <li>• Move forward or back to another point in the film.</li> <li>• Press <b>Enter</b> again.</li> </ul> Replay ends when you press <b>Enter</b> , <b>Play</b> , or <b>Stop</b> .

## Loading and playing a CD

1. On the remote, press the **CD/DVD** button.
2. At the media center, press the **Stop/Eject**  button.
3. Place the audio CD in the open disc tray.
4. Press the **Stop/Eject**  button to close the disc tray.

The CD will start to play automatically. If it does not, press **Play** .

While playing a CD, the display window on the media center indicates:

- Track number
- Track time
- Repeat or Shuffle mode

### Basic CD operations

#### If you want to:

Pause a CD...

Resume play of paused CD...

Stop a CD...

Go to next track...

Go to beginning of current track...

Go to a previous track...

Scan a CD backward/forward...

Randomly play CD tracks...

Cancel random play...

#### Use the remote to do this:

Press **Pause** .

Press **Pause**  again or **Play** .

Press **Stop** .

Press **Track**  up.

After track has played for several seconds, press **Track**  down.

If track has played for several seconds, press **Track**  down twice. If not, press once.

Press and hold **Scan**  or .

Press **Shuffle**  after loading a CD.

Press **Shuffle**  again, while in that mode.

### Changing CD settings

While the system is in CD mode, press the **Settings** button on the remote control to gain access to the options shown here. For more details on changes you can make to the settings, refer to the Sound Adjustments and System Adjustments sections that follow in this guide.



Selection:	CD setting options:	What the setting affects:
<b>Sleep Timer:</b>	Off mm:ss	Timer not set. Set to turn system off (not the components) when time (01:00 to 90:00 minutes) expires.
<b>Track:</b>	1 of n	Chooses the CD track by number.
<b>Track Time:</b>	h:mm:ss	Moves to that time/place in the track.
<b>CD Status</b>	selection	Displays information about the CD source.
<b>Audio Setup</b>	selection	See Sound Adjustments page 40.
<b>System Setup</b>	selection	See System Adjustments page 42.

### Using the sleep timer

Your system includes a sleep timer which can be set to turn your system off automatically after 1 to 90 minutes of listening to any source. This timer can be accessed through the Settings menu. See “Locating system settings” on page 42.

**Note:** Remember that system controls, like the sleep timer, will not turn off the TV or other sound source components.

### Using the radio

Press  or  on the remote to select the radio tuner. If the system is off, this will turn it on to the most recently selected station in that band.

### Tuning

You can tune to a radio station in the following ways:

**If you want to:**

**Do this:**

Switch bands

Press  or  on the remote for the band you want.

Seek the strongest stations

Press and hold **Seek** ◀ or ▶ on the remote until the radio begins seeking. Release to stop at the next strongest station.

To stop sooner, briefly press **Seek** ◀ or ▶.

To begin seeking again without holding down the skip button, briefly press **Seek** ◀ or ▶ again as soon as the first seek operation stops.

Manually tune to a station

Press **Tune** ▲ or ▼ on the remote.

Select a preset station

Press **Preset** 

or Press that number on the keypad.

While the system is in AM or FM mode, and the TV is on, you can press the **Settings** button on the remote control to gain access to the options available for that band. For more details on changes you can make to the settings, refer to the Sound Adjustments and System Adjustments sections that follow in this guide.

### Storing preferred stations as preset selections

For radio stations that you listen to regularly, you can assign a preset number (1-25 in the AM band and 1-25 in FM) to tune to them quickly.

To store a particular station:

1. Tune to that station using the **Tune**, **Seek**, or **Scan** buttons on the remote.
2. Press **Enter**. A preset number blinks while **STORE?** appears on the media center display.
3. Press **Enter** to store the station to that blinking number.

 **Note:** If you want to change the station assigned to a particular preset number, you must first delete the station already assigned to it.

To erase the station assigned to a particular preset number:

1. Tune to the preset station.
2. Press **Enter**. The preset number blinks while **ERASE?** appears on the media center display.
3. Press **Enter** to remove the station from that assigned preset number. That number is now available for storing a different station.







### Selecting a preset station

You can select preset stations using the remote control or the on-screen settings menu.

#### To select a preset with the remote control:

- Using the numbered keys on the remote control, press the number(s) for the preset station you want to hear.
- Press **Preset** up or down to change the preset number.

#### To select a preset using the settings menu:

1. Press  or  on the remote to select the AM or FM source.
2. Press . (Make sure your TV is on.)
3. Press  to select **Preset**.
4. Press  or  to step through the preset stations.

### Changing FM settings

Selection:	FM setting options:	What the setting affects:
<b>Sleep Timer:</b>	Off	Timer not set.
	mm:ss	Sets timer to turn off when time (01:00 to 90:00 minutes) expires.
<b>Station:</b>	----	Tunes to that station frequency.
<b>Preset:</b>	1 of 25	Tunes to the stored preset station.
<b>FM Status</b>	selection	Displays information about the FM source.
<b>RDS info:</b> (for Europe only)	On	Makes RDS information appear in media center display.
	Off	Makes RDS information not appear on media center display.
<b>Output mode:</b>	Stereo	Always plays the FM broadcast in stereo.
	Mono	Always plays the FM broadcast in mono.
<b>Audio Setup</b>	selection	See Sound Adjustments page 40.
<b>System Setup</b>	selection	See System Adjustments page 42.

### Changing AM settings

Selection:	AM setting options:	What the setting affects:
<b>Sleep Timer:</b>	Off	Timer not set.
	mm:ss	Sets timer to turn off when time (01:00 to 90:00 minutes) expires. Refer to "Using the sleep timer" on page 37.
<b>Station:</b>	----	Tunes to that station frequency.
<b>Preset:</b>	1 of 25	Tunes to the stored preset station.
	Available only if presets include an AM station	
<b>AM Status</b>	selection	Displays information about the AM source.
<b>Audio Setup</b>	selection	See Sound Adjustments page 40.
<b>System Setup</b>	selection	See System Adjustments page 42.

### Playing other sources

Turn on any component connected to the media center by using the remote for that component or controls on the component front panel.

Pressing **AUX**, **Video 1** or **Video 2** on the 3•2•1 or 3•2•1 GS system remote turns on the system and selects the audio for that component. Be sure a tape or disc is loaded, as needed.

Use the **Volume ▲** or **▼** buttons on the 3•2•1 or 3•2•1 GS system remote control or on the media center to raise or lower the volume of the system.

To control all other functions of that source, use its remote or front panel controls. For details on what changes you can make, refer to the owner's manual that came with the component.

To record to a connected tape deck, play the built-in or connected source (AM/FM, CD, or AUX) you want to tape. Listen to the speakers to be sure you have selected the audio you want to tape. Set the tape deck to Record.

### Changing settings for the other sources

Selection:	Setting options:	What the setting affects:
<b>Sleep Timer:</b>	Off	Timer not set.
	mm:ss	Sets timer to turn off when time (01:00 to 90:00 minutes) expires. Refer to "Using the sleep timer" on page 37.
<b>VID 1, VID 2, AUX Status:</b>	selection	Displays information about the connected source.
<b>Audio Setup</b>	selection	See Sound Adjustments page 40.
<b>System Setup</b>	selection	See System Adjustments page 42.

### System settings

When necessary, the system settings can be changed using the System Settings menus. See "Locating system settings" on page 42.

## Locating Audio Setup

1. Turn on both the media center and your TV.
2. Press the **Settings** button on the remote. A menu of the available settings for the current source will be displayed on your TV screen.
3. Using the **Tune ▼** button, scroll down the list and select (highlight) **Audio Setup**.
4. Press the **Enter** button and the audio settings will be displayed for the current source.

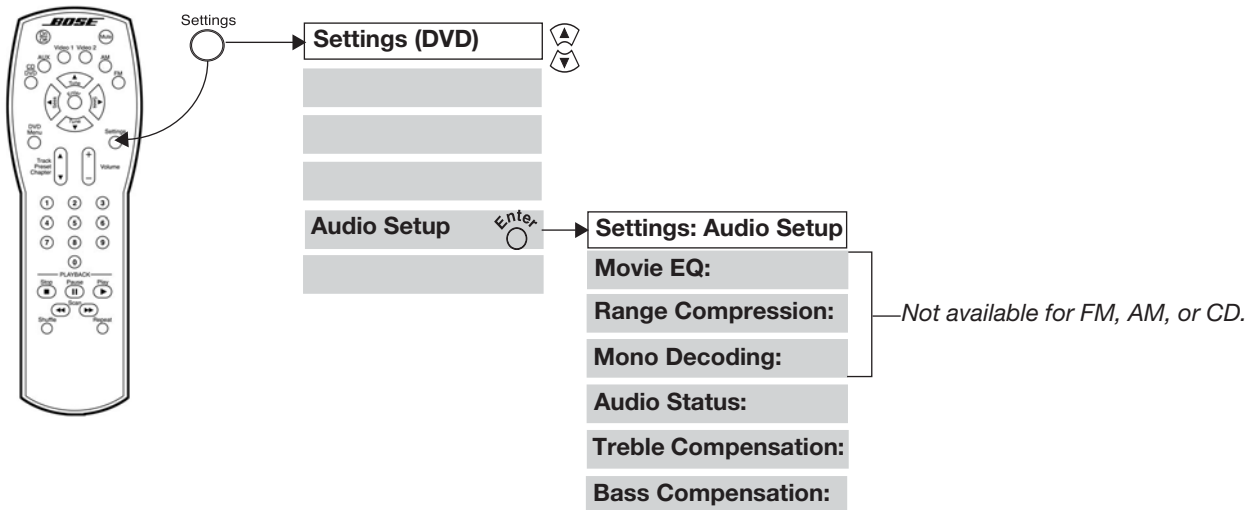

### Audio Setup menu

Selection:	Setting options:	What the setting affects:
<b>Movie EQ:</b>	On	Sets proper equalization for this particular movie.
<b>Range Compression:</b>	On	Automatically adjusts the volume so you can hear soft sounds (particularly dialogue) and are not overwhelmed by loud special effects, like an explosion. This feature is normally engaged when you turn the system on to DVD, VIDEO 1, VIDEO 2, or AUX.
	Off	Range compression not active.
<b>1 + 1:</b>	1 of n	Not shown above. Indicates that a Dolby 1+1 audio track is playing.
<b>Mono Decoding:</b>	On	Automatically engages Bose® Videostage® decoding circuitry when a Dolby Digital bitstream indicates that it contains a mono program. This feature can process a one-channel program in multi-speaker sound, directing the signals so that dialogue remains locked on-screen, while music and ambient effects fill the room.
	Off	Mono decoding not active.
<b>Audio Status</b>	selection	Displays system audio information. The example in Figure 28 on page 41 shows the DVD audio status.



<b>Treble Compensation:</b>	-15 to +15	<p>Decreases(-) or increases (+) the treble sound.</p> <p>Rooms with too few sound-absorbing furnishings, especially those with bare floors and walls, may sound overly shrill or “bright.” Lowering this setting to a negative value (-1 to -15) decreases the treble sound.</p> <p>Rooms with a lot of sound-absorbing furnishings, such as upholstered furniture, wall-to-wall carpet, or heavy drapes, may reduce the treble sound of your system. Moving speakers farther away from soft furnishings increases treble. You can also increase the treble sound by raising this setting to a positive value (+1 to +15).</p>
<b>Bass Compensation:</b>	-15 to +15	<p>Decreases (-) or increases (+) the bass sound.</p> <p>Placement of the Acoustimass® module affects the amount of bass you hear. Placing the module closer to the corner of the room will increase the bass. Moving the module away from the corner will decrease the bass.</p> <p>You can also decrease the bass sound by lowering this setting to a negative value (-1 to -15). To increase the bass, raise this setting to a positive value (+1 to +15).</p>

**Figure 28**

DVD audio status

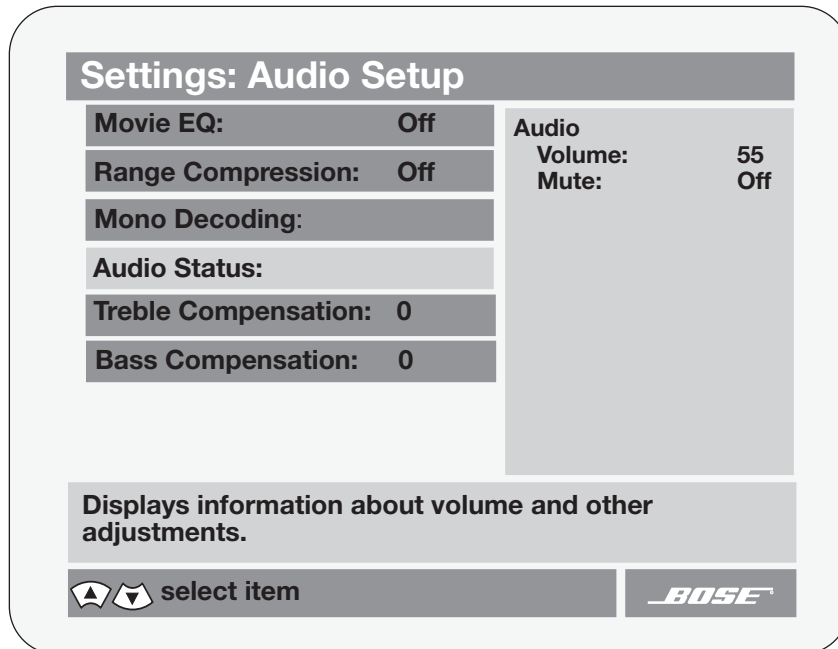

## Locating system settings

1. Turn on both the media center and your TV.
2. Press the **Settings** button. A menu of the available settings for the current source will be displayed on your TV screen.
3. Using the **Tune** ▼ button, scroll down the list and select (highlight) **System Setup**.
4. Press the **Enter** button and the System Setup will be displayed.

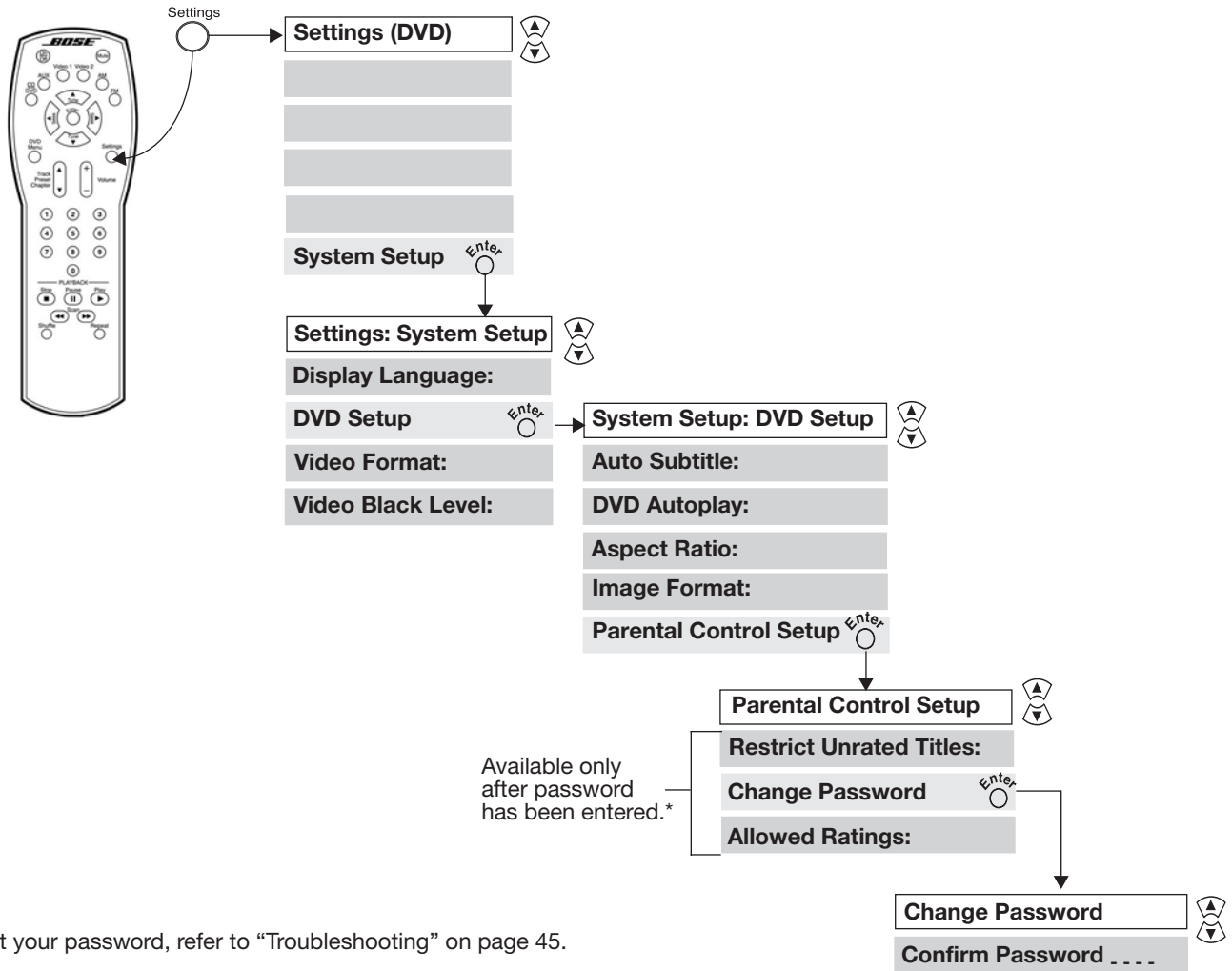

\*If you forget your password, refer to “Troubleshooting” on page 45.

### System Setup menu

The System Setup menu lists options for how to set up the entire system.

Selection:	Setting options:	What the setting affects:
<b>Display Language:</b>	English/French/ Spanish/etc.	Presents on-screen display menus in the selected language.
<b>DVD Setup</b>	selection	Provides a selection of options, including Parental Control, for the DVD.
<b>Video Format:</b>	NTSC PAL	Sets video format to the USA standard. Sets video format to the European standard.
<b>Video Black Level:</b>	Normal Extended	Sets black level required for most TVs. Sets black level that may be appropriate for DVD playback.

### DVD Setup submenu

The DVD Setup submenu lists options for how the DVD player should operate, including Parental Control.

Selection:	Setting options:	What the setting affects:
<b>Auto Subtitle:</b>	On Off	Subtitles, if available on a particular DVD, are automatically displayed when the audio is muted. DVD subtitles are not displayed automatically.
<b>DVD Autoplay:</b>	On Off	DVD starts to play automatically when it is loaded. DVD is not started automatically when loaded.
<b>Aspect Ratio:</b>	4:3 16:9	Provides the DVD aspect ratio for standard (4:3) TVs. Provides the DVD aspect ratio for widescreen (16:9) TVs.
<b>Image Format:</b>	Pan & Scan Letterbox	Images are sized to fit a standard TV, if a particular DVD allows it. Images are presented in Letterbox format if a particular DVD allows it (with black bars at the top and bottom of the screen). If <b>Aspect Ratio</b> is 16:9, <b>Image Format</b> is not applicable and the setting is automatically shown as "--".
<b>Parental Control Setup</b>	selection	Provides access to the Parental Control submenu.

## Taking care of your 3•2•1 or 3•2•1 GS system

Caring for your system may include cleaning the system's enclosures, cleaning your discs, and replacing the remote control batteries.

### Cleaning the media center

- Use only a soft, dry cloth to clean the outside surfaces of the media center.
- Do not use any sprays near the system. Do not use any solvents, chemicals, or cleaning solutions containing alcohol, ammonia, or abrasives.
- Do not allow liquids to spill into any openings.

### Cleaning the speakers

- Clean the surface of your speakers with a soft, damp cloth. You can use an ammonia-free window cleaner on a soft cloth to maintain the finish.
- Do not use any sprays near the speakers. Do not use any solvents, chemicals, or cleaning solutions containing alcohol, ammonia, or abrasives.
- Do not allow liquids to spill into any openings.
- The speaker grilles require no special care, although you may vacuum them carefully if necessary.

### Cleaning discs

- Handle discs by their edges to prevent fingerprints and scratches (Figure 29a).
- To remove stains or fingerprints from the surface of a disc, use a soft and dry lint-free cloth. Wipe in straight movements from the center of the disc to the outside (Figure 29b). Do not use any chemical products; they can damage the disc.
- Do not use a circular motion to clean (Figure 29c).
- Do not write on or attach labels to the surface of a disc.
- To minimize exposure to dust and dirt, return discs to their cases after use. Store each disc in its case, away from direct sunlight, high temperatures, and humidity.

**Figure 29**

Disc care

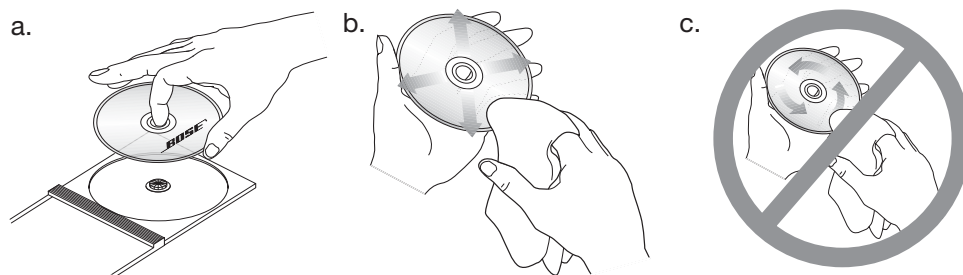

### Replacing the remote control batteries

Slide open the battery compartment (Figure 30).

Notice the polarity markings (+ and -) inside the compartment and install the batteries accordingly. Slide the battery compartment cover back into place.

**Figure 30**

Putting in the batteries

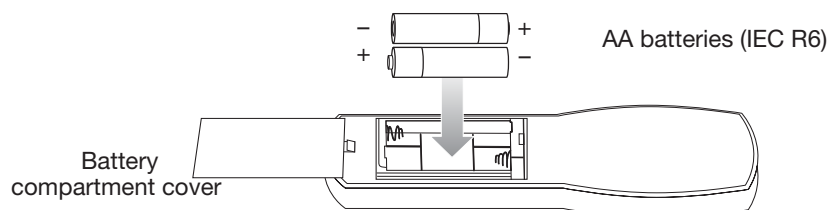

## Troubleshooting

Problem	What to do
System doesn't do anything	<ul style="list-style-type: none"> <li>• Make sure the unit is turned on.</li> <li>• Make sure the power cord is inserted securely into the Acoustimass® module and plugged firmly into an operating AC wall outlet.</li> <li>• Be sure to select a source (CD/DVD, AM/FM, etc.).</li> <li>• Unplug the Acoustimass module power cord from the outlet for one minute, then reconnect it. This allows the unit to reset itself. After reconnecting the power cord, wait for the message, "BOSE 321" to appear on the media center display.</li> </ul>
Disc won't eject	<ul style="list-style-type: none"> <li>• Turn off the unit.</li> <li>• Unplug the Acoustimass module power cord from the outlet for one minute, then reconnect it. This allows the unit to reset itself.</li> <li>• Unplug the Acoustimass module power cord from the outlet for one minute, then reconnect it. This allows the unit to reset itself.</li> <li>• <b>Before</b> powering on, press and hold <b>STOP/EJECT</b>.</li> </ul>
No sound	<ul style="list-style-type: none"> <li>• Increase the volume.</li> <li>• Check to see if <b>MUTE</b> is lit on the display. If it is, press the <b>Mute</b> button on the remote control to unmute the sound.</li> <li>• Make sure the module cable and speaker cable are firmly seated in the media center jacks and the multi-pin connector on the other end is firmly seated in the Acoustimass module jack.</li> <li>• Check speaker connections.</li> <li>• Turn the media center off for 10 seconds, then on again, to restore communication between the media center and the speakers.</li> <li>• Check the connections for any external components. Make sure to select the correct source for the desired input.</li> <li>• Be sure the disc is placed correctly, label-side up, in the CD tray.</li> <li>• Connect the FM and AM antennas.</li> <li>• Unplug the Acoustimass module power cord from the outlet for a minute, then reconnect it. This allows the unit to reset itself.</li> </ul>
Sound, but no picture	<ul style="list-style-type: none"> <li>• Make sure the TV is on.</li> <li>• When playing a DVD or other video source, make sure the TV is set for TV/Video. See "Make note of the video input jack you use" on page 17.</li> </ul>
Remote control is inconsistent or does not work	<ul style="list-style-type: none"> <li>• Check batteries and their polarity (+ and -). See "Replacing the remote control batteries" on page 44.</li> <li>• Point the remote control at the media center.</li> </ul>
Radio does not work or has poor reception	<ul style="list-style-type: none"> <li>• Make sure antennas are connected properly.</li> <li>• Move AM antenna at least 20 inches (50 cm) from the media center.</li> <li>• Adjust antenna position to improve reception.</li> <li>• AM antenna must be upright.</li> <li>• Move antennas farther from TV or other electronic equipment.</li> <li>• You may be in an area of weak signal coverage.</li> </ul>
DVD or CD does not play	<ul style="list-style-type: none"> <li>• Check to see if the play symbol in the display is lit.</li> <li>• After pressing the CD/DVD button, wait a few seconds before pressing <b>Play</b>.</li> <li>• Make sure the disc is properly inserted (label side up).</li> <li>• Eject the disc and try loading it again.</li> <li>• There may be dirt or dust on the disc. Clean the disc. See "Cleaning discs" on page 44.</li> <li>• The disc may be defective. Try another disc.</li> <li>• Make sure region codes for both the DVD and player match. See "Check for region code compatibility" on page 5.</li> </ul>

<b>Problem</b>	<b>What to do</b>
FM sound is distorted	<ul style="list-style-type: none"> <li>Adjust antenna position to reduce interference.</li> </ul>
Sound is distorted	<ul style="list-style-type: none"> <li>Make sure speaker cables are not damaged and the connections are secure.</li> <li>Reduce the output level from any external components connected to the music center.</li> </ul>
Picture is black and white or rolling	<ul style="list-style-type: none"> <li>Check the video cable connections.</li> <li>Check the Video Format setting and change to appropriate setting (NTSC or PAL). See "System settings" on page 39.</li> </ul>
You forgot your password	<ul style="list-style-type: none"> <li>Enter the password 2673 to access the parental controls and create a new password.</li> </ul>

### Customer service

For additional help in solving problems, contact Bose® customer service. Refer to the address list included in the carton.

### Warranty

The Bose® 3•2•1 and 3•2•1 GS home entertainment systems are covered by a limited transferable warranty. Details of the warranty are provided on the warranty card that came with your system. Please fill out the information section on the card and mail it to Bose.

### Accessories

The Bose 3•2•1 and 3•2•1 GS system shelf speakers are compatible with Bose mounting accessories, including the UB-20 wall brackets, UFS-20 floor stands and UTS-20 table stands. Bose also offers cable adapters for use in running speaker cable through walls.

For further information or to order the advanced remote control, mounting brackets, stands, or cable adapters, contact your Bose dealer. Or, to call Bose directly, refer to the address sheet included with the system.

## Technical information

### Power rating

USA/Canada: 120VAC, 60 Hz, 300W  
 Dual voltage: 115/230VAC, 50/60 Hz, 300W  
 UK/Europe: 230VAC, 50/60 Hz, 300W  
 Australia: 240VAC, 50/60 Hz, 300W  
 Singapore: 220VAC, 50/60 Hz, 300W

### Inputs

AUX, VIDEO 1, VIDEO 2: 2VRMS maximum  
 EXTERNAL ANTENNA: 75 ohm

### Outputs

1 audio output  
 1 video output

### Maximum ambient temperature

40°C

### Dimensions

Media center:

4 $\frac{1}{8}$ "H x 13 $\frac{1}{4}$ "W x 10 $\frac{1}{4}$ "D  
 (10.4 cm x 33.9 cm x 26.0 cm)

Remote control:

1 $\frac{1}{8}$ "H x 2 $\frac{1}{2}$ "W x 8 $\frac{1}{16}$ "D  
 (3.0 cm x 6.5 cm x 20.5 cm)

3•2•1 speakers:

3 $\frac{1}{2}$ "H x 7 $\frac{7}{8}$ "W x 5 $\frac{1}{4}$ "D  
 (8.7 cm x 19.9 cm x 13.6 cm)

3•2•1 GS speakers:

4"H x 5 $\frac{1}{2}$ "W x 2 $\frac{1}{2}$ "D  
 (10.5 cm x 14 cm x 6.4 cm)

Acoustimass® module:

14 $\frac{1}{2}$ "H x 8 $\frac{3}{4}$ "W x 19 $\frac{1}{8}$ "D  
 (36.7 cm x 22.2 cm x 48.5 cm)

### Weights

Media center: 8.8 lb (4.0 kg)

3•2•1 speakers: 2.7 lb (1.2 kg) each

GS speakers: 1 lb (.45 kg) each

Acoustimass module: 23.3 lb (10.6 kg)

### Finish

Media center: polymer

Speakers: polymer

Acoustimass module: polymer

## Setup codes for cable

## Códigos de instalación para cable

## Codes de configuration pour le câble

ABC.....	0003, 0008, 0014, 0007, 0011, 0013, 0017, 0033, 0047	Goodmind.....	0797
Ajinvision.....	1271	Grundig.....	0529
Alcatel.....	0896, 0897	Hamlin.....	0009, 0020, 0034, 0259, 0273
Allegro.....	0153, 0315	Hitachi.....	0014, 0011, 0033, 0255
Americast.....	0899	Hwalin.....	0303
Amstrad.....	1222	HyperVision.....	0619
Anvision.....	0111, 0211	Hytex.....	0007
Archer.....	0153, 0797	IEEC.....	1018
BT.....	0105	Jasco.....	0015, 0153, 0315
Bell & Howell.....	0014	Jebsee.....	0400
Bell South.....	0899	Jerrold.....	0476, 0003, 0276, 0012, 0014, 0015, 0011, 0024, 0047, 0098, 0810
Bestlink.....	0303	Kuang Yu.....	0024
Birmingham Cable Communications.....	0276	LG.....	0144, 0040, 0779, 0838
British Telecom.....	0003, 0105	Leon.....	0015, 0069
Cable & Wireless.....	1068	MNet.....	0019, 0443
Cabletime.....	0271, 0377, 0448, 0665	MS.....	0015, 0069, 0303, 1018
Century.....	0153	Macab.....	0817
Citizen.....	0153, 0315	Macom.....	0033
Colour Voice.....	0025, 0031	Magnavox.....	0032, 0069
Comtec.....	0274	Memorex.....	0000
Comtronics.....	0040, 0060	Motorola.....	0476, 1106, 0276, 0810
Contec.....	0019	Movie Time.....	0063, 0078
Cryptovision.....	0600	Mr. Zap.....	1112
Daehan.....	0778	NET.....	0274
Daeryung.....	0877, 0008, 0277, 0477, 1877	NSC.....	0063, 0070
Decsat.....	0423	NTL.....	1068
Director.....	0476	Noos.....	0817
Eastern.....	0002, 0274, 0418	Now.....	0776
Electricord.....	0078	Oak.....	0019, 0007, 0248, 0303
Emerson.....	0797	Ono.....	1068
Everquest.....	0015, 0040	Optimus.....	0021
Filmnet.....	0443	PVP Stereo Visual Matrix.....	0003
Focus.....	0400	Pace.....	0237, 1060, 1068
France Telecom.....	0451, 0817, 0896, 0897	Pacific.....	0678
Funai.....	0019, 0248	Pacific Bell.....	0843
GHZ.....	0078	Panasonic.....	0008, 0000, 0107, 0021, 0040
GMI.....	0015, 0057, 0069, 0797	Paragon.....	0000
Galaxi.....	0008	Philips.....	0305, 0317, 0013, 0025, 0031, 0032, 0060, 0069, 0111, 0153, 0211, 0242, 0255, 0290, 0451, 0619, 0652, 0817
Garrard.....	0153	Pioneer.....	0877, 0144, 0533, 0023, 1021, 1877
Gemini.....	0015, 0057, 0070, 0242, 0797	Popular Mechanics.....	0400
General Instrument.....	0476, 0003, 0276, 0014, 0015, 0011, 0024, 0098, 0810	Pulsar.....	0000
GoldStar.....	0144, 0040, 0838	Quasar.....	0000
Golden		RCA.....	0021, 0843

AM271966\_0011.pdf August 18, 2003



RadioShack.....	0015, 0303, 0315, 0797	Wiso.....	0078
Rampage.....	0255	Zenith.....	0000, 0525, 0899
Recoton.....	0400	Zentek.....	0400
Regal.....	0020, 0259, 0273, 0279		
Regency.....	0002		
Rembrandt.....	0011, 0070		
Runco.....	0000		
SL Marx.....	0040		
Sagem.....	0817, 1089		
Samsung.....	0144, 0000, 0040, 0070, 0702, 0840		
Scientific Atlanta.....	0877, 0008, 0017, 0277, 0477, 1877		
SeWoo.....	0073		
Seawoo.....	0780		
Sharp.....	0313		
Signal.....	0015, 0040		
Signature.....	0011		
Sony.....	1006		
Sprucer.....	0021		
Starcom.....	0003, 0014, 0015, 0047, 0098		
Stargate.....	0015, 0040, 0797		
Starquest.....	0015		
Storm.....	1018		
Supercable.....	0276		
TS.....	0003, 0024, 0255, 0303, 1018		
TV86.....	0063		
Tadiran.....	0040		
Tae Kwang.....	0068		
Taepyung.....	0678		
Taihan.....	0778		
Teac.....	1018		
Tele Danmark.....	1016		
Tele+1.....	0443		
Televue.....	0040		
Telewest.....	1068		
Thomson.....	1110		
Timeless.....	0274, 0418		
Tocom.....	0012, 0013		
TongKook.....	0777, 0840		
Torx.....	0003		
Toshiba.....	0000		
Trans PX.....	0276, 0153, 0303, 0315		
Tudi.....	0286		
Tusa.....	0015		
UBS.....	0073		
Unika.....	0153		
United Artists.....	0007		
United Cable.....	0003		
Universal.....	0078, 0153, 0191		
Videoway.....	0250		
Viewstar.....	0060, 0063, 0111, 0211		
Visionetics.....	1064, 1264		
Visiopass.....	0451		
Westminster.....	0105, 0716		

AM271966\_00\_V.pdf August 18, 2003

## Setup codes for satellite

## Códigos de instalación para satellite

## Codes de configuration pour le satellite

@sat.....	1300	Best.....	0217, 0369
ABsat.....	0123, 0668, 0832	Bestar.....	0243
AGS.....	0668, 0710	Birdview.....	0045
ASA.....	0397	Blaupunkt.....	0173
ASLF.....	0713	Boca.....	0132, 0243, 0589, 0683, 0713, 0794, 0829
AST.....	0321, 0351	Brain Wave.....	0332, 0692
Aegir.....	0520	British Sky Broadcasting.....	0847, 1175
Akai.....	0200, 0515	Broco.....	0530, 0713
Akena.....	0668	Bubu Sat.....	0713
Alba.....	0421, 0455, 0515, 0519, 0613, 0713, 0734	Bush.....	0067, 0183
Aldes.....	0288, 0519, 0520, 0734	CNT.....	0520
Allsat.....	0067, 0183, 0200, 0364, 0734	Cambridge.....	0515, 0683
Allsonic.....	0288, 0369	Canal Digital.....	0853
Alltech.....	0713	Canal Satellite.....	0853
Alpha.....	0668	Canal+.....	0853
AlphaStar.....	0772	Channel Master.....	0018
Amitronica.....	0713	Chaparral.....	0216
Ampere.....	0368, 0396	CityCom.....	0115, 0394, 0607, 0818, 1176
Amstrad.....	0080, 0132, 0243, 0252, 0338, 0345, 0396, 0461, 0501, 0713, 0742, 0795, 0847, 1113	Clatronic.....	0332
Amway.....	0043	Colombia.....	0668
Anglo.....	0713	Columbia.....	0132
Ankaro.....	0217, 0288, 0369, 0519, 0692, 0713	Columbus.....	0668
Anttron.....	0183, 0421, 0613	CommLink.....	0288
Apollo.....	0421	Condor.....	0369, 0607
Arcon.....	0100, 0217, 0332, 0368, 0692, 0834, 1043, 1205	Conifer.....	0004
Armstrong.....	0243	Connexions.....	0396
Asat.....	0200	Conrad.....	0115, 0369, 0589, 0607
Astacom.....	0668	Contec.....	0394, 0589
Aston.....	0142, 1129, 1261	Cosat.....	0592
Astra.....	0108, 0145, 0243, 0530, 0607	Crossdigital.....	1109
Astro.....	0173, 0358, 0369, 0501, 0520, 0548, 0613, 0658	Crown.....	0243
Athena.....	0668	Cyrus.....	0200
Atsat.....	1300	D-box.....	0723, 0873, 1127
AudioTon.....	0364, 0613	DMT.....	1075
Avalon.....	0396	DNR.....	0692
Axiel.....	0668	DNT.....	0200, 0396
Axis.....	0369, 0530, 0834	DST.....	0421
BEC.....	1303	DX Antenna.....	0041, 0752
BT.....	0515, 0668, 0710	Dae Young.....	0735
BVV.....	0692	Daeryung.....	0396
Barcom.....	0217	Daewoo.....	0713, 1296
Bell Express.....	0167	Dansat.....	0183
		Daumling.....	0794
		Dgtec.....	1242
		Digenius.....	0299
		DirectTV.....	0392, 0566, 0639, 1142, 0247, 0749, 0724, 0819, 1076, 1109, 1749, 1856

AM271966\_00\_V.pdf August 18, 2003

Discovery.....	0668, 0710	General Instrument.....	0869, 0038, 0361, 0627
Dish Network System..	1005, 0775	Gold Box.....	0292, 0853
DishPro.....	1005, 0775	GoldStar.....	0335
Diskxpress.....	0217	Gooding.....	0571
Distratel.....	0084, 0885	Goodmans.....	0455, 1246, 1284
Ditristrad.....	0592	Gradiente.....	0887
Drake.....	0018, 0064, 0245	Granada.....	0108, 0455
Dream Multimedia.....	1237	Grandin.....	0417
Dune.....	0369	Grothusen.....	0335
Dynasat.....	0679	Grundig.....	0139, 0140, 0173, 0345, 0571, 0750, 0805, 0847, 0879
EIF.....	0417	HDT.....	1011, 1159
EP Sat.....	0455	HTS.....	0775
Echostar.....	1005, 0775, 0100, 0148, 0159, 0167, 0170, 0218, 0269, 0280, 0312, 0396, 0453, 0454, 0465, 0511, 0610, 0616, 0668, 0688, 0713, 0853, 0871, 1086, 1169	Hanseatic.....	0605
Einhell.....	0243, 0252, 0288, 0421, 0501, 0517, 0713, 0794	Hantor.....	0332, 0421
Elta.....	0200, 0364, 0369, 0421	Hanuri.....	0520
Emanon.....	0421	Hase & Igel.....	0692
Emme Esse.....	0369, 0679, 0871	Heliocom.....	0368
Engel.....	0713, 1017	Helium.....	0607
Eurieult.....	0417	Hinari.....	0183, 0421
Eurocrypt.....	0108, 0455	Hirschmann.....	0173, 0396, 0397, 0398, 0495, 0501, 0573, 0882, 1085
Europa.....	0501, 0589	Hisawa.....	0332
Eurosat.....	0243	Hitachi.....	0819, 0214, 0455, 0489, 0491, 1250
Eurosky.....	0243, 0369, 0607	Houston.....	0461, 0592, 0668
Eurostar.....	0100, 0607, 0679, 1025, 1026	Hughes Network Systems .....	1142, 0749, 1749
Exator.....	0421, 0515, 0613	Humax.....	0283, 0863, 1176
Expressvu.....	0775	Hung Chang.....	0732
Extra Sat.....	0519	Huth.....	0243, 0288, 0332, 0364, 0368, 0388, 0517, 0589, 0607, 0794, 0829
FTE.....	0100, 0331, 0368, 0369, 0589, 0683, 0713, 0863	Hwalin.....	0885
Fenner.....	0668	Hypson.....	0417
Ferguson.....	0036, 0067, 0183, 0336, 0455, 0711	Hyundai.....	0758, 1011, 1159
Fidelity.....	0252, 0368, 0461, 0501	IEEC.....	0605
Finlandia.....	0108, 0455	IR.....	0067, 0108, 0173, 0183, 0217, 0252, 0331, 0338, 0358, 0455, 0461
Finlux.....	0108, 0397, 0455, 0573	IRTE.....	0609
Force NO AS.....	1101	ISkyB.....	0887
Foxtel.....	0879	ITT.....	0108, 0172
Fracarro.....	0421, 0668, 0871	Ikusi Allsat.....	0368
Freecom.....	0335, 0421, 0501, 0734	InVideo.....	0871
Fresat.....	0885	Indovision.....	0887
Fuba.....	0108, 0172, 0173, 0217, 0369, 0394, 0396, 0417, 0421, 0573	Intersat.....	0043
Funai.....	0338	Intertronic.....	0243
G-Sat.....	0183	Intervision.....	0592, 0607, 0628
GE.....	0566	JOK.....	0690, 0710
GOI.....	0775	JSR.....	0364
Galaxi.....	0217	JVC.....	0775, 0492, 0505, 0506, 0515, 0571
Galaxis.....	0283, 0288, 0364, 0369, 0530, 0592, 0692, 0833, 0834, 0863, 1101, 1111	Jerrold.....	0036, 0361, 0627
Galaxisat.....	0321	JiWon.....	0364
Gardiner.....	0816	Johansson.....	0332, 0364
		K-SAT.....	0713
		KR.....	0613, 0734

AM271966 0016.pdf August 18, 2003

Kabil.....	0737	Micro Tech.....	0530
Kathrein.....	0123, 0173, 0200, 0249, 0331, 0358, 0394, 0442, 0480, 0553, 0613, 0622, 0658, 0713, 0742, 1057, 1221	Microtec.....	0713
KeyWest.....	0794	Minerva.....	0571
Kolon.....	0421	Mitsubishi.....	0749, 0455, 0491
Kosmos.....	0331, 0335, 0442	Morgan's.....	0132, 0200, 0243, 0364, 0589, 0683, 0713, 0794, 0829
Kreismeyer.....	0173	Motorola.....	0869
Kuangyu.....	0635	Multichoice.....	0642, 0879
Kyostar.....	0421, 0613	Multistar.....	0331
L&S Electronic.....	1043	Muratto.....	0335
LG.....	0335, 0461, 1226	Myryad.....	0200
LaSAT.....	0115, 0243, 0369, 0520, 0607, 0683	Mysat.....	0713
Labgear.....	1296	NEC.....	0178, 0496, 0499, 0507, 0508, 1270
Legend.....	0269	Navex.....	0332
Lemon.....	0692	Netgem.....	1322
Lenco.....	0335, 0421, 0530, 0605, 0692, 0713	Netsat.....	0887
Lennox.....	0592	Neuhaus.....	0501, 0530, 0589, 0592, 0692, 0713, 0834
Lenson.....	0501	Neusat.....	0692, 0713, 0834
Leyco.....	0515	Next Level.....	0869
Lifesat.....	0369, 0605, 0713, 1122	NextWave.....	0732
Loewe.....	0243	Nikko.....	0200, 0243, 0713, 0734
Logix.....	1017	Nokia.....	0108, 0172, 0397, 0455, 0573, 0723, 0751, 0873, 1023, 1127, 1723
Lorenzen.....	0299, 0607, 0692, 0742, 0794, 1294	Nordmende.....	0421, 0455, 0520
Lorraine.....	0335	Norsat.....	0004
Lupus.....	0369	Novis.....	0332
Luxor.....	0108, 0172, 0345, 0573	Now.....	0757
M&B 1.....	0605	OSAT.....	0345
Macab.....	0004	Octagon.....	0421, 0613
Macom.....	0018	OctalTV.....	1005
Magnavox.....	0724, 0722	Okano.....	0243, 0331, 0668
Manata.....	0710	Optex.....	0394, 0417, 0834
Manhattan.....	0455, 0520, 0592, 1017, 1083	Orbit.....	0351, 1022
Marantz.....	0200	Orbitech.....	0421, 0501, 0548, 0589, 1100
Marave.....	0417	Oxford.....	0515, 0668
Mascom.....	0520	Pace.....	0067, 0183, 0200, 0241, 0336, 0455, 0497, 0720, 0791, 0795, 0847, 0867, 0887, 1175, 1323
Maspro.....	0041, 0173, 0336, 0495, 0571, 0713, 0750	Palladium.....	0243, 0421, 0501, 0571
Master's.....	0394	Palsat.....	0501
Matsui.....	0173, 0571, 0710	Panasat.....	0615, 0879
Matsushita.....	0214, 0340, 0500	Panasonic.....	0247, 0701, 0214, 0340, 0455, 0500, 0739, 0847, 1104, 1320
Max.....	0607	Panda.....	0067, 0108, 0455
MediaSat.....	0292, 0501, 0530, 0853	Pantech.....	0747
Mediabox.....	0292	Paristad.....	0417
Mediamarkt.....	0243	Patriot.....	0515, 0668
Medion.....	0369, 0713	Paysat.....	0724
Mega.....	0200	Philips.....	1142, 0749, 0724, 1076, 0722, 0133, 0173, 0183, 0200, 0217, 0292, 0455, 0571, 0589, 0613, 0710, 0750, 0805, 0853, 0898, 1118, 1749
Memorex.....	0724, 0269	Phoenix.....	0183
Metronic.....	0084, 0243, 0288, 0421, 0519, 0520, 0613, 0713, 1282		
Metz.....	0173		
Micro.....	0713		
Micro Elektronik.....	0713		

AM271966 00 V1.pdf August 18, 2003

Phonotrend.....	0288, 0592	Satelco.....	0369
Pioneer.....	0292, 0329, 0352, 0662, 0853	Satline.....	0628
Planet.....	0396	Satplus.....	1009
Plasmatic.....	0442	Satstation.....	1083
Polytron.....	0394, 0396	Schacke.....	0613
Praxis.....	0733, 1123	Schneider.....	0668, 0805
Predki.....	0332, 0421	Schwaiger.....	0116, 0183, 0394, 0589, 0605, 0732, 1111
Preisner.....	0132, 0589	Sedea Electronique....	0421
Premier.....	0292, 0592	Seemann.....	0243, 0396, 0515, 0530
Prima.....	0795	Seleco.....	0592, 0871
Primestar.....	0361, 0627	Sharp.....	0494
ProVision.....	0520	Siemens.....	0173, 0683
Profile.....	0710	Silva.....	0335
Promax.....	0455	Skantin.....	0713
Prosat.....	0288, 0628	Skardin.....	0530
Proscan.....	0392, 0566	Sky Television.....	1014
Provisat.....	0520	Skylife.....	1255
Pye.....	0571	Skymaster.....	0240, 0288, 0519, 0605, 0628, 0713, 0880
Pyxis.....	0834	Skymax.....	0200
Quadral.....	0288, 0369, 0519, 0589, 0628, 0668	Skytwin.....	0519
Quelle.....	0252, 0607	Skyvision.....	0364
RCA.....	0392, 0566, 0855, 0143	Smart.....	0132
RFT.....	0200, 0288	Sony.....	0639, 0163, 0275, 0292, 0294, 0661, 0847
Radio Shack.....	0869	Star.....	0887
Radiola.....	0200	Star Choice.....	0869
Radix.....	0396, 0882, 1113, 1255	Star Trak.....	0421
Rainbow.....	0613	Starcast.....	0042
Rediffusion.....	0004	Starland.....	1122
Redpoint.....	0530	Starring.....	0332
Redstar.....	0369	Strong.....	0132, 0369, 0421, 0520, 0613, 0879, 1105, 1147, 1159, 1300
Roadstar.....	0713	Sumida.....	0243
Rover.....	0628, 0713	Sunny Sound.....	0369
SAT.....	0321, 0351, 0461, 0501	Sunsat.....	0530, 0713
SEG.....	0369, 0421, 0519, 0605, 0742, 1087	Sunstar.....	0243, 0369, 0794, 0829
SKR.....	0713	Super Sat.....	0679
SKY.....	0856, 0887	Supernova.....	0887
SL Marx.....	0692	TPS.....	0820, 1253
SM Electronic.....	0157, 0240, 0587, 0713, 1200	Tada.....	0368
STS.....	0037, 0041	Tae Kwang.....	0733
STVI.....	0417	Tagra.....	0364
Saba.....	0183, 0336, 0520, 0690, 0692, 0710, 0734, 0885	Tantec.....	0336, 0455
Sabre.....	0455	Tatung.....	0145, 0455
Sagem.....	0820, 1114, 1253	TechniSat.....	0005, 0501, 0548, 1099, 1100
Salora.....	0108, 0172	Techniland.....	0592
Samsung.....	1109, 0773, 1017, 1243, 1244, 1276, 1293	Technowelt.....	0607
Sanyo.....	0493, 1219	Teco.....	0243
Sat Control.....	1300	Telasat.....	0605
Sat Team.....	0368, 0713	Teleciel.....	0613, 0734
SatPartner.....	0332, 0335, 0421, 0501, 0520, 0613, 0692, 0734	Teledirekt.....	0183
Satcom.....	0605	Telefunken.....	0421
Satec.....	0183, 0713, 0834	Teleka.....	0243, 0396, 0501, 0613, 0692, 0750

AM271966\_00\_V.pdf August 18, 2003

Telemaster.....	0520
Telesat.....	0605
Telestar.....	0114, 0157, 0501, 1100
Televes.....	0455, 0501, 0734
Televisa.....	0887
Telewire.....	0592
Ten Haaft.....	0692
Thomson.....	0115, 0265, 0292, 0455, 0607, 0711, 0713, 0853, 1012, 1046, 1291, 1900
Thorn.....	0455
Tioko.....	0394
Tonna.....	0455, 0501, 0592, 0668
Topfield.....	1206
Toshiba.....	0749, 0790, 0082, 0137, 0455, 0486, 1749
Triad.....	0321, 0335, 0351, 0372
Triasat.....	0501
Triax.....	0115
Twinner.....	0136, 0417
UltimateTV.....	0392, 0639
Uniden.....	0724, 0722, 0194
Unisat.....	0200, 0243
Unitor.....	0217, 0332
Universum.....	0115, 0173, 0397, 0571, 0607, 0742
VTech.....	0321, 0351, 0690, 0818
Variosat.....	0173
Ventana.....	0200
Vestel.....	0742
Victor.....	0492, 0505, 0506
Visiosat.....	0690
Vortec.....	0421
Wela.....	0589, 0713, 0794
Wetekom.....	0829
Wewa.....	0455
Winersat.....	0332, 1045
Wintergarten.....	0288
Wisi.....	0004, 0173, 0321, 0351, 0372, 0396, 0406, 0455, 0589, 0638, 0690
Woorisat.....	0520
Worldsat.....	0710
XSat.....	0123, 0668
Xcom Multimedia.....	0668
Xrypton.....	0369
Yes.....	0887
Zaunkonig.....	0692
Zehnder.....	0114, 0321, 0331, 0369, 0520, 0742, 0818, 1075
Zenith.....	0856, 0064, 0245, 0635, 1856
Zeta Technology.....	0200
Zodiac.....	0613
Zwergnase.....	0243, 0794, 0829

AM271966\_00\_V.pdf August 18, 2003

## Setup codes for television

### Códigos de instalación para TV

### Codes de configuration pour la télévision

A-Mark.....	0003	Anglo.....	0264
A.R. Systems.....	0556	Anitech.....	0282, 0009, 0037, 0068, 0076, 0264, 0474
AGB.....	0516	Ansonic.....	0009, 0037, 0102, 0292, 0370, 0428
AOC.....	0451, 0093, 0180, 0060, 0030, 0178, 0019, 0179, 0018, 0003, 0009, 0052, 0092, 0108, 0137, 0185, 0474	Apex Digital.....	0748, 0765, 0767, 1943
ASA.....	0087, 0104	Arc En Ciel.....	0196, 0399
AWA.....	0009, 0157	Arcam.....	0216, 0217
Abex.....	0032	Archer.....	0003
Acura.....	0009	Aristona.....	0037, 0556
Addison.....	0092, 0108, 0653	Asberg.....	0076, 0102
Admiral.....	0093, 0463, 0087, 0163, 0213, 0363	Asora.....	0009
Advent.....	0761, 0815, 0817, 1933	Asuka.....	0217, 0218, 0264
Adventura.....	0046	Atlantic.....	0206, 0320
Adyson.....	0032, 0068, 0216, 0217	Audinac.....	0391
Agef.....	0087	AudioTon.....	0217, 0264, 0428, 0486
Aiko.....	0092, 0217, 0264	Audiosonic.....	0009, 0037, 0109, 0217, 0218, 0264, 0337, 0370, 0428, 0486
Aiwa.....	0701, 0705, 1904, 1910, 1914, 1915, 1916	Audiovox.....	0451, 0180, 0003, 0092, 0623
Akai.....	0030, 0009, 0035, 0037, 0072, 0098, 0163, 0191, 0208, 0218, 0329, 0361, 0371, 0433, 0448, 0480, 0516, 0548, 0556, 0581, 0602, 0631, 0672, 0696, 0702, 0708, 0812	Autovox.....	0076, 0087, 0206, 0217, 0247, 0336
Akib.....	0294	BPL.....	0282, 0037
Akiba.....	0282, 0037, 0218, 0294, 0455	BSR.....	0294
Akito.....	0272	BTC.....	0218
Akura.....	0282, 0009, 0037, 0218, 0264, 0283, 0358, 0412, 0493	Baird.....	0072, 0073, 0190, 0193, 0208, 0217, 0343
Alaron.....	0179, 0183, 0216	Bang & Olufsen.....	0087, 0275, 0565
Alba.....	0009, 0036, 0037, 0049, 0163, 0211, 0216, 0218, 0235, 0247, 0371, 0418, 0487, 0581, 0668	Barco.....	0380
Alfide.....	0672	Basic Line.....	0282, 0009, 0037, 0217, 0218, 0374, 0455, 0567
Allorgan.....	0206, 0217, 0294	Baur.....	0010, 0037, 0065, 0146, 0303, 0349, 0361, 0505, 0512, 0535, 0554
Allstar.....	0037	Baysonic.....	0180
Ambassador.....	0177	Bazin.....	0217
America Action.....	0180	Beaumarck.....	0178
Amplivision.....	0217, 0320, 0370, 0400	Beko.....	0037, 0370, 0428, 0486, 0714, 0715
Ampro.....	0751	Belcor.....	0019
Amstrad.....	0009, 0037, 0171, 0177, 0218, 0264, 0354, 0371, 0412, 0433, 0516, 0581	Bell & Howell.....	0154, 0016
Anam.....	0250, 0180, 0003, 0004, 0009, 0068, 0161, 0425, 0426, 0628, 0700	Beon.....	0032, 0037, 0418
Anam National.....	0250, 0055, 0161, 0425, 0650	Best.....	0337, 0370, 0421
		Bestar.....	0037, 0370, 0374
		Binatone.....	0217
		Blaupunkt.....	0191, 0195, 0200, 0213, 0327, 0328, 0535, 0554
		Blue Sky.....	0282, 0037, 0218, 0455, 0668, 1037
		Blue Star.....	0282
		Bondstec.....	0247
		Boots.....	0217, 0272
		Bradford.....	0180

AM271966\_00\_V.pdf August 18, 2003

AM271966\_00\_V.pdf August 18, 2003

Brandt.....	0109, 0196, 0198, 0205, 0287, 0335, 0399	Conic.....	0032
Brinkmann.....	0037, 0418, 0519	Conrac.....	0808
Brionvega.....	0087	Contec.....	0180, 0009, 0036, 0157, 0158, 0185, 0216
Britannia.....	0216, 0217	Continental Edison.....	0109, 0196, 0198, 0205, 0287, 0399, 0487
Brockwood.....	0019	Cosmel.....	0037, 0337
Broksonic.....	0236, 0463, 0003, 0426, 1905, 1911, 1929, 1935, 1938	Craig.....	0180, 0161
Bruns.....	0087	Crezar.....	0213
Bush.....	0282, 0007, 0009, 0036, 0037, 0208, 0211, 0217, 0218, 0264, 0272, 0294, 0349, 0355, 0361, 0363, 0371, 0374, 0487, 0519, 0581, 0614, 0617, 0668, 0698, 1037, 1900	Crosley.....	0054, 0074, 0076, 0084, 0087, 0213, 0247
CCE.....	0037, 0217, 0329	Crown.....	0180, 0039, 0009, 0037, 0076, 0208, 0339, 0370, 0418, 0421, 0486, 0579, 0672
CGE.....	0074, 0076, 0084, 0247, 0370, 0418	Crown Mustang.....	0672
CS Electronics.....	0216, 0218, 0247	Curtis Mathes.....	0047, 0054, 0154, 0451, 0093, 0060, 0030, 0145, 0056, 0016, 0039, 0166, 0466, 0702, 0747, 1147, 1347, 1919
CTC.....	0247	Cybertron.....	0218
CXC.....	0180	DER.....	0190, 0193
Candle.....	0030, 0056, 0046, 0186	Daewoo.....	0154, 0451, 0180, 0030, 0178, 0019, 0056, 0039, 0003, 0004, 0009, 0032, 0037, 0066, 0091, 0092, 0108, 0170, 0217, 0218, 0374, 0391, 0402, 0474, 0499, 0623, 0624, 0627, 0628, 0634, 0661, 0700, 1902, 1909, 1921, 1928
Canton.....	0218	Dainichi.....	0216, 0218
Carad.....	0610	Dansai.....	0032, 0035, 0036, 0037, 0216
Carena.....	0037, 0455	Dantax.....	0486
Carnivale.....	0030	Dayton.....	0009
Carrefour.....	0036, 0037, 0057	Daytron.....	0019, 0374
Carver.....	0054, 0170	De Graaf.....	0208, 0227, 0363, 0548
Cascade.....	0009, 0037	Decca.....	0033, 0037, 0049, 0072, 0217, 0272, 0516
Cathay.....	0037, 0474	Denko.....	0264
Celebrity.....	0000	Denon.....	0145, 0511
Celera.....	0765	Denver.....	0037
Centurion.....	0037	Desmet.....	0009, 0037
Century.....	0087, 0213, 0247	Diamant.....	0037
Changhong.....	0765	Digatron.....	0037
Ching Tai.....	0179, 0003, 0009, 0092, 0474	Dixi.....	0004, 0009, 0037
Chun Yun.....	0000, 0180, 0179, 0003, 0009, 0033, 0092, 0161, 0474	Domland.....	0394
Chung Hsin.....	0180, 0053, 0033, 0036, 0108, 0474	Dual.....	0037, 0057, 0217, 0259, 0303, 0336, 0394, 0519, 0531
Cimline.....	0009, 0218	Dual Tec.....	0217
Cinema.....	0672	Dumont.....	0017, 0019, 0070, 0087, 0102, 0213
Cineral.....	0451, 0092	Dwin.....	0720, 0774
Citizen.....	0060, 0030, 0056, 0039, 0046, 0092, 0186, 0280, 0561, 1928, 0561, 1928	Dynatech.....	0049
City.....	0009	ECE.....	0037
Clairtone.....	0185	EMI.....	0005
Clarion.....	0180	Ectec.....	0391
Clarivox.....	0037, 0102	Elbe.....	0217, 0238, 0259, 0292, 0411, 0435, 0516
Clatronic.....	0009, 0037, 0076, 0102, 0217, 0218, 0247, 0320, 0370, 0371, 0579	Electroband.....	0000, 0185
Clayton.....	0385	Electrohome.....	0381, 0389, 0409
Colt.....	1906		
Concerto.....	0056		
Condor.....	0282, 0009, 0037, 0102, 0247, 0320, 0370, 0411		

AM271966\_00\_V.pdf August 18, 2003



Elekta.....	0264	GE.....	0047, 0051, 0451, 0180, 0282, 0030, 0178, 0021, 0055, 0027, 0029, 0092, 0135, 0174, 0279, 0560, 0747, 1147, 1347, 1454, 1907, 1917, 1919, 1922
Elin.....	0009, 0037, 0104, 0349, 0361, 0448, 0548	GEC.....	0037, 0043, 0072, 0163, 0205, 0217, 0361, 0516
Elite.....	0218, 0320	GPM.....	0218
Elman.....	0102	Galaxi.....	0037, 0102
Elta.....	0009, 0068, 0474	Galaxis.....	0037, 0370
Emco.....	0247	Gateway.....	1755, 1756
Emerson.....	0154, 0236, 0463, 0180, 0282, 0178, 0019, 0179, 0039, 0037, 0038, 0070, 0087, 0158, 0177, 0181, 0182, 0183, 0185, 0213, 0247, 0280, 0320, 0361, 0371, 0623, 1905, 1909, 1911, 1928, 1929	Geloso.....	0009, 0213, 0363, 0374
Emperor.....	0282	General.....	0186, 0590
Envision.....	0030, 0813	General Technic.....	0009
Erres.....	0012, 0037	Genexxa.....	0009, 0163, 0218, 0493
Ether.....	0030, 0003, 0009, 0161	Germanvox.....	0213
Etron.....	0009, 0283, 0646	Gibraltar.....	0017, 0030, 0019
Euroman	0037, 0264, 0421	Gintai.....	0354, 0474, 0721
Europa.....	0037	GoldStar.....	0154, 0030, 0178, 0019, 0056, 0039, 0001, 0002, 0032, 0037, 0106, 0109, 0163, 0216, 0217, 0247, 0283, 0290, 0308, 0361, 0363, 0377, 0409, 0457, 0467
Europhon.....	0102, 0213, 0217, 0516	Goldline.....	0337
Expert.....	0206	Goldstar.....	1926
Exquisit.....	0037	Gooding.....	0487
FNR.....	0102	Goodmans.....	0179, 0009, 0032, 0035, 0036, 0037, 0072, 0217, 0218, 0235, 0264, 0335, 0343, 0360, 0371, 0374, 0480, 0487, 0499, 0516, 0560, 0624, 0634, 1900, 1909
Fenner.....	0009, 0374	Gorenje.....	0370, 0421
Ferguson.....	0005, 0037, 0073, 0109, 0190, 0192, 0193, 0238, 0287, 0335, 0343, 0560, 0625	Gradiente.....	0053, 0056, 0170, 0392
Fidelity.....	0082, 0163, 0193, 0216, 0264, 0361, 0363, 0371, 0412, 0474, 0512	Graetz.....	0163, 0361
Filsai.....	0217	Granada.....	0037, 0045, 0072, 0108, 0146, 0208, 0217, 0226, 0339, 0356, 0363, 0473, 0502, 0516
Finlandia.....	0072, 0163, 0208, 0346, 0363, 0548	Grandin.....	0282, 0009, 0037, 0163, 0320, 0374, 0455, 0579, 0610
Finlux.....	0179, 0037, 0070, 0072, 0087, 0102, 0104, 0105, 0217, 0346, 0411, 0516	Grundig.....	0009, 0037, 0070, 0076, 0191, 0195, 0205, 0487, 0535, 0554, 0556, 0587, 0672, 0706, 1935
Firstar.....	0236, 0009, 0033	Grunpy.....	0180, 0179
Firstline.....	0009, 0037, 0072, 0216, 0217, 0238, 0247, 0294, 0374, 0385, 0411, 0531, 0668	HCM.....	0282, 0009, 0037, 0217, 0218, 0264, 0412, 0418
Fisher.....	0047, 0154, 0036, 0045, 0072, 0087, 0104, 0157, 0159, 0208, 0217, 0303, 0370	HMV.....	0087
Flint.....	0037, 0072, 0218, 0264, 0455, 0610	Haier.....	0768
Forgestone.....	0193	Halifax.....	0217
Formenti.....	0037, 0065, 0087, 0213, 0216, 0320	Hallmark.....	0178
Fortress.....	0093	Hampton.....	0216, 0217
Fraba.....	0037, 0370	Hanimex.....	0294, 1908
Friac.....	0009, 0102, 0370, 0499	Hankook.....	0180, 0030, 0178, 0019, 0056, 0409, 0628
Frontech.....	0009, 0163, 0217, 0247, 0264, 0363, 0448, 0474	Hanseatic.....	0282, 0009, 0037, 0217, 0320, 0361, 0377, 0394, 0428, 0519, 0556, 0661
Fujitsu.....	0179, 0072, 0102, 0186, 0206, 0217, 0683, 0809	Hantarex.....	0037, 0213, 0516
Funai.....	0180, 0179, 0171, 0264, 0294, 0303, 0342, 1904	Hantor.....	0037
Futuretech.....	0180		
GBC.....	0009, 0037, 0102, 0216, 0217, 0238, 0247, 0294, 0374, 0385, 0411, 0531, 0668		

AM271966\_000\_V.pdf August 18, 2003

Harley Davidson.....	0179, 0043, 1904	ITV.....	0037, 0264
Harman/Kardon.....	0054, 0078	Iberia.....	0037
Harvard.....	0180, 0068	Imperial.....	0074, 0076, 0084, 0247, 0370, 0418
Harwood	0009, 0032, 0037, 0412	Indesit.....	0213
Havermy.....	0093	Indiana.....	0037
Hello Kitty.....	0451	Infinity.....	0054
Hema.....	0009, 0217	Ingelen.....	0163
Hifivox.....	0196, 0198, 0399	Ingersol.....	0009
Hikona.....	0218, 0474	Inkel.....	0571
Hinari.....	0179, 0039, 0009, 0036, 0037, 0211, 0218, 0235, 0283, 0355, 0487, 1908	Inno Hit.....	0009, 0072, 0217, 0290, 0516
Hisawa.....	0282, 0218, 0400, 0455, 0610	Innova.....	0037
Hit.....	0087	Inteq.....	0017
Hitachi.....	0165, 0030, 0178, 0145, 0019, 0179, 0056, 0016, 0039, 0009, 0027, 0032, 0036, 0037, 0038, 0043, 0044, 0072, 0092, 0095, 0097, 0105, 0109, 0151, 0157, 0163, 0182, 0186, 0194, 0196, 0198, 0213, 0217, 0225, 0227, 0279, 0349, 0356, 0363, 0381, 0409, 0413, 0473, 0474, 0481, 0492, 0499, 0516, 0548, 0576, 0577, 0578, 0583, 0719, 0744, 1045, 1225, 1256, 1904	Interbuy.....	0037, 0068, 0264
Hornophone.....	0037	Interfunk.....	0012, 0037, 0087, 0163, 0247, 0275, 0327, 0361, 0512
Hua Tun.....	0009	Internal.....	0037
Huanyu.....	0216, 0374	Intervision.....	0282, 0037, 0068, 0102, 0217, 0218, 0247, 0264, 0377, 0394, 0448, 0455, 0486, 0487, 0519
Hyper.....	0009, 0216, 0217, 0247	Irradio.....	0218, 0247, 0290, 0371
Hypersonic.....	0361	Isukai.....	0282, 0037, 0218, 0455
Hypson.....	0282, 0037, 0264, 0400, 0455	JBL.....	0054
ICE.....	0216, 0217, 0218, 0264, 0371, 0556	JCB.....	0000
ICeS.....	0216, 0218	JEC.....	0502
IR.....	0093, 0007, 0010, 0011, 0012, 0032, 0033, 0035, 0036, 0037, 0043, 0045, 0070, 0072, 0073, 0074, 0076, 0087, 0101, 0102, 0104, 0105, 0108, 0109, 0146, 0157, 0163, 0190, 0191, 0192, 0193, 0194, 0195, 0196, 0205, 0206, 0213, 0216, 0217, 0225, 0226, 0227, 0235, 0238, 0243, 0247, 0274, 0287, 0290, 0291, 0292, 0294, 0303, 0320, 0327, 0343, 0349, 0354, 0356, 0361, 0363, 0370, 0374, 0448, 0505, 0512, 0516, 0535, 0553, 0554, 0556	JVC.....	0463, 0053, 0036, 0069, 0094, 0160, 0169, 0182, 0190, 0192, 0193, 0218, 0371, 0418, 0606, 0653, 0683, 1923
IRT.....	0628	Janeil.....	0046
ITS.....	0216, 0264, 0371	Jean.....	0156, 0051, 0236, 0179, 0003, 0009, 0092, 0474, 0721
ITT.....	0179, 0007, 0163, 0208, 0283, 0339, 0346, 0349, 0361, 0473, 0480, 0548, 0549	Jensen.....	0761, 0815, 0817, 1933

AM271966\_00\_V.pdf August 18, 2003

Kolin.....	0180, 0053, 0033, 0036, 0108, 0474	Majestic.....	0016, 0015
Kolster.....	0037	Manesth.....	0035, 0037, 0217, 0235, 0264, 0294, 0320
Konka.....	0218, 0371, 0628, 0632, 0638, 0703, 0707, 0725, 0726, 1939, 1940	Marantz.....	0054, 0030, 0037, 0556
Korpel.....	0037	Marelli.....	0087
Korting.....	0087, 0320, 0421	Mark.....	0037
Kosmos.....	0037	Maruman.....	0391, 0627
Koyoda.....	0009	Matsui.....	0009, 0011, 0033, 0035, 0036, 0037, 0072, 0163, 0177, 0191, 0195, 0208, 0211, 0217, 0235, 0272, 0294, 0335, 0354, 0355, 0363, 0371, 0433, 0443, 0455, 0487, 0516, 0579
Kraking.....	0238	Matsushita.....	0250, 0161, 0650
Kuba Electronic.....	0303	McMichael.....	0043
Kyoshu.....	0032, 0412	Mediator.....	0012, 0037
Kyoto.....	0032, 0163, 0385	Medion.....	0037, 0668, 0808, 1037
L&S Electronic.....	0808	Megas.....	0610
LG.....	0060, 0030, 0178, 0019, 0056, 0001, 0003, 0004, 0032, 0037, 0038, 0108, 0409, 0442, 0474, 0644, 0700, 0714, 1934	Megatron.....	0178, 0145, 0003
LXI.....	0047, 0054, 0154, 0156, 0178, 0148, 0747	Melvox.....	0400
LaSAT.....	0486	Memorex.....	0154, 0250, 0463, 0150, 0178, 0179, 0056, 0016, 0009, 0106, 1037, 1911, 1920, 1924, 1926, 1927
Lenco.....	0104	Memphis.....	0337, 0385
Leyco.....	0037, 0072, 0264, 0294, 0579	Mercur.....	0001
Liesenk & Tter.....	0037	Metz.....	0037, 0087, 0213, 0275, 0367, 0388, 0447, 0535, 0554, 0746
Liesenkotter.....	0037, 0327	Micromaxx.....	0808
Lifetec.....	0037, 0218, 0374, 0519	Microstar.....	0808
Lloyd's.....	1904	Midland.....	0047, 0017, 0051, 0039, 0032, 0135, 0747
Lloytron.....	0032	Minerva.....	0070, 0487, 0535, 0554
Loewe.....	0037, 0087, 0136, 0292, 0512, 0633, 0694	Minoka.....	0412
Logik.....	0016, 0001, 0005, 0011, 0033, 0193	Minutz.....	0021
Luma.....	0206, 0259, 0363	Mirror.....	1900
Lumatron.....	0217	Mitsubishi.....	0154, 0250, 0093, 0236, 0180, 0150, 0030, 0178, 0019, 0179, 0056, 0007, 0014, 0033, 0036, 0037, 0087, 0098, 0108, 0155, 0331, 0354, 0358, 0381, 0474, 0512, 0535, 1917
Luxman.....	0056	Mivar.....	0216, 0290, 0291, 0292, 0516, 0609
Luxor.....	0163, 0194, 0208, 0290, 0349, 0356, 0361, 0363, 0548	Monaco.....	0009
M Electronic.....	0009, 0037, 0057, 0068, 0104, 0105, 0109, 0163, 0216, 0217, 0247, 0287, 0346, 0374, 0411, 0480, 0492, 0512	Motion.....	0076
MEI.....	0185	Motorola.....	0093, 0055
MGA.....	0150, 0030, 0178, 0019, 0155, 1907	Multibroadcast.....	0193
MTC.....	0060, 0030, 0019, 0056, 0049, 0091, 0185, 0216, 0349, 0370, 0512	Multitech.....	0180, 0009, 0049, 0076, 0102, 0216, 0217, 0247, 0363, 0486
MTEC.....	0032, 0272	Murphy.....	0039, 0072, 0163, 0216, 0474
Magnadyne.....	0087, 0102, 0247, 0516	Myryad.....	0556
Magnafon.....	0073, 0076, 0102, 0213, 0216, 0516	NAD.....	0156, 0178, 0361, 0866
Magnasonic.....	1913, 1928	NEC.....	0154, 0156, 0051, 0165, 0030, 0178, 0019, 0056, 0009, 0036, 0046, 0170, 0186, 0320, 0381, 0455, 0474, 0497, 0704, 1704
Magnavox.....	0054, 0030, 0179, 0020, 0024, 0028, 0036, 0096, 0186, 0187, 0230, 0386, 1254, 1454, 1904, 1913, 1931	NEI.....	0037, 0337, 0371
Magnin.....	1907	NTC.....	0092
Magnum.....	0037, 0648		

AM271966\_00\_V.pdf August 18, 2003

Naiko.....	0606	Otto Versand.....	0093, 0010, 0036, 0037, 0109, 0191, 0213, 0217, 0226, 0235, 0247, 0294, 0303, 0320, 0343, 0349, 0361, 0505, 0512, 0535, 0554, 0556
Nakimura.....	0037, 0374	Pael.....	0216
Nakio.....	0480	Palladium.....	0363, 0370, 0411, 0418
Naonis.....	0363	Panama.....	0217, 0247, 0264
National.....	0226	Panasonic.....	0054, 0250, 0051, 0055, 0037, 0126, 0161, 0163, 0213, 0214, 0226, 0274, 0338, 0340, 0361, 0367, 0516, 0548, 0650, 1650, 1919, 1924, 1927, 1930, 1941, 1946, 1947
Neckermann.....	0037, 0087, 0191, 0213, 0247, 0320, 0327, 0349, 0363, 0370, 0411, 0418, 0505, 0554, 0556	Panavision.....	0037, 0411
Nesco.....	0179, 0247	Pathe Cinema.....	0163, 0213, 0216, 0238, 0320
Netsat.....	0037	Pathe Marconi.....	0196, 0198, 0205, 0399
Network.....	0032, 0337	Pausa.....	0009
Neufunk.....	0037, 0556	Penney.....	0047, 0156, 0051, 0060, 0030, 0178, 0021, 0019, 0018, 0039, 0002, 0003, 0027, 0032, 0110, 0135, 0149, 0747, 1347, 1907, 1919, 1926
New Tech.....	0217, 0343	Perdio.....	0037, 0163, 0320
Newave.....	0093, 0178, 0009, 0092, 0161, 0721	Phase.....	0032
Nicamagic.....	0216	Philco.....	0054, 0463, 0180, 0030, 0178, 0145, 0019, 0056, 0020, 0028, 0032, 0037, 0074, 0076, 0084, 0087, 0096, 0186, 0213, 0247, 0278, 0370, 0409, 0418, 0474, 0628, 0747, 1911
Nikkai.....	0009, 0032, 0035, 0036, 0037, 0072, 0216, 0217, 0218, 0264, 0337	Philips.....	0054, 0000, 0051, 0030, 0178, 0019, 0056, 0007, 0012, 0020, 0024, 0028, 0032, 0037, 0043, 0087, 0092, 0108, 0186, 0187, 0193, 0278, 0332, 0343, 0374, 0409, 0423, 0474, 0554, 0556, 0595, 0721, 0747, 1454
Nikko.....	0030, 0178, 0092	Phoenix.....	0087, 0216, 0320, 0385, 0486
Nisato.....	0391	Phonola.....	0012, 0037, 0087, 0193, 0216
Noblex.....	0430	Pilot.....	0030, 0019, 0039
Noblisko.....	0070, 0076, 0102, 0216	Pioneer.....	0037, 0038, 0109, 0163, 0166, 0172, 0287, 0361, 0423, 0428, 0486, 0679, 0760, 0866
Nogamatic.....	0196	Plantron.....	0009
Nokia.....	0179, 0163, 0208, 0320, 0339, 0346, 0349, 0361, 0374, 0473, 0480, 0548, 0567, 0606, 0610, 0631, 1912	Playsonic.....	0217
Norcent.....	0748, 0824	Polytron.....	0697
Nordmende.....	0109, 0195, 0196, 0198, 0213, 0287, 0343, 0399, 0560	Portland.....	0019, 0039, 0092, 0374
Noshi.....	0018	Prandoni-Prince.....	0213, 0361, 0363, 0516
Novak.....	0012	Precision.....	0217
Novatronic.....	0037, 0105, 0531	Prima.....	0068, 0264, 0474, 0761, 0815, 0817, 1933
Oceanic.....	0163, 0208, 0361, 0548, 0567	Princeton.....	0700, 0717
Okano.....	0009, 0037, 0264, 0370	Prinz.....	0194
Omega.....	0264	Prism.....	0051
On Command.....	0531	Profex.....	0009, 0076, 0163, 0361, 0363
Onking.....	0280	Profi.....	0009
Onwa.....	0180, 0102, 0218, 0371, 0433, 0581	Profitronic.....	0037, 0102
Optimus.....	0154, 0250, 0166, 0650, 1913, 1924, 1927		
Optonica.....	0093, 0165		
Orion.....	0236, 0463, 0179, 0037, 0177, 0211, 0235, 0294, 0320, 0355, 0443, 0474, 0516, 0531, 0655, 1905, 1911, 1929		
Orline.....	0037, 0218		
Ormond.....	0385		
Orsowe.....	0516		
Osaki.....	0032, 0037, 0072, 0217, 0218, 0264, 0272, 0355, 0374, 0412, 0474, 0493		
Osio.....	0037		
Oso.....	0218		
Osume.....	0032, 0036, 0037, 0072, 0157, 0218, 0474		

AM271966\_00\_V.pdf August 18, 2003

Proline.....	0072	SEI.....	0010, 0087, 0102, 0177, 0206, 0213, 0294, 0516
Proscan.....	0047, 0747, 1922	SEI-Sinudyne.....	0037, 0213
Prosonic.....	0037, 0579	SKY.....	0037
Protech.....	0009, 0037, 0102, 0217, 0247, 0264, 0337, 0418, 0668	SSS.....	0180, 0019
Proton.....	0030, 0178, 0039, 0001, 0003, 0009, 0031, 0052, 0149, 0466, 0474, 0644	Saba.....	0087, 0109, 0163, 0196, 0198, 0205, 0213, 0287, 0335, 0343, 0361, 0399, 0498, 0516, 0548, 0560, 0625
Pulsar.....	0017, 0019	Saccs.....	0238
Pye.....	0007, 0012, 0037, 0087, 0554, 0556	Sagem.....	0455, 0610
Quasar.....	0250, 0051, 0165, 0055, 0247, 0474, 0650, 1919, 1924	Saisho.....	0009, 0011, 0033, 0177, 0211, 0217, 0235, 0264, 0354, 0516
Quelle.....	0010, 0011, 0037, 0070, 0074, 0084, 0104, 0200, 0213, 0327, 0328, 0361, 0505, 0512, 0535, 0554	Salora.....	0163, 0194, 0290, 0349, 0356, 0361, 0363, 0516, 0548
Questa.....	0032, 0036	Sambers.....	0076, 0102, 0213, 0516
Questar.....	0032	Sampo.....	0154, 1755, 0093, 0030, 0178, 0039, 0009, 0032, 0036, 0052, 0092, 0110, 0171, 0474, 0650, 0700, 0721
R-Line.....	0037	Samsung.....	0154, 0060, 0030, 0178, 0019, 0179, 0056, 0039, 0009, 0032, 0037, 0072, 0090, 0092, 0110, 0208, 0216, 0217, 0264, 0278, 0290, 0329, 0370, 0409, 0427, 0448, 0474, 0482, 0519, 0556, 0587, 0618, 0644, 0702, 0747, 0766, 0812, 1903
RBM.....	0070	Samsux.....	0039
RCA.....	0047, 0000, 0030, 0178, 0019, 0018, 0029, 0038, 0090, 0092, 0135, 0174, 0278, 0679, 0747, 1047, 1147, 1247, 1347, 1447, 1454, 1547, 1907, 1917, 1919, 1922, 1948	Sandra.....	0216, 0217
RFT.....	0072, 0087, 0428	Sansei.....	0451
RTF.....	0087	Sansui.....	0463, 0037, 0655, 0706, 1904, 1911, 1929
Radialva.....	0037, 0218, 0337	Sanyo.....	0154, 0180, 0011, 0036, 0045, 0068, 0072, 0088, 0104, 0107, 0108, 0146, 0157, 0159, 0208, 0213, 0216, 0217, 0232, 0280, 0339, 0370, 0376, 0381, 0424, 0474, 0484, 0799, 1907
RadioShack.....	0047, 0154, 0165, 0180, 0030, 0178, 0019, 0056, 0039, 0032, 0037, 0409, 0747, 1904, 1920	Sanyong.....	0032
Radiola.....	0012, 0037, 0217	Schaub Lorenz.....	0361
Radiomarelli.....	0037, 0087, 0247, 0516	Schneider.....	0012, 0037, 0057, 0217, 0218, 0247, 0259, 0303, 0336, 0361, 0371, 0394, 0519, 0556, 0668, 1137, 1904
Radiotone.....	0009, 0037, 0264, 0428, 0579	Scimitsu.....	0019
Rank Arena.....	0036	Scotch.....	0178
Realistic.....	0154, 0165, 0180, 0030, 0178, 0019, 0056, 0039, 0032	Scotland.....	0163
Recor.....	0037	Scott.....	0236, 0180, 0178, 0019, 0179
Rediffusion.....	0361, 0548	Sears.....	0047, 0054, 0154, 0156, 0178, 0179, 0056, 0015, 0146, 0148, 0149, 0159, 0171, 0747, 1904, 1926
Redstar.....	0037	Seleco.....	0163, 0206, 0259, 0363, 0411
Reflex.....	0037	Semivox.....	0180
Recc.....	0714	Semp.....	0156
Revox.....	0037	Sencora.....	0009
Rex.....	0163, 0206, 0259, 0264, 0363, 0411	Sentra.....	0035, 0218, 0283
Rhapsody.....	0183, 0185, 0216		
Roadstar.....	0009, 0037, 0218, 0264, 0418		
Robotron.....	0087		
Rowa.....	0698, 0712		
Roxy.....	0448		
Royal Lux.....	0412		
Runco.....	0017, 0030, 0497, 0603		
SBR.....	0007, 0012, 0037, 0043, 0193		
SEG.....	0009, 0036, 0037, 0076, 0102, 0217, 0264, 0668		

AM271966\_00\_V.pdf August 18, 2003

Serino.....	0216, 0455, 0610	SuperTech.....	0009, 0037, 0216
Sharp.....	0093, 0165, 0030, 0039, 0032, 0036, 0153, 0157, 0220, 0256, 0294, 0386, 0409, 0474, 0491, 0516, 0589, 0650, 0688, 0689, 0787, 0818, 1093, 1193, 1917	Superla.....	0516
Shen Ying.....	0179, 0003, 0009, 0092, 0474	Supra.....	0056, 0039, 0009
Sheng Chia.....	0093, 0236, 0179, 0009, 0033, 0474	Supre-Macy.....	0046
Shintoshi.....	0037	Supreme.....	0000
Shogun.....	0019	Susumu.....	0218, 0474
Shorai.....	0179, 0294	Sylvania.....	0054, 0030, 0020, 0028, 0065, 0096, 0171, 0186, 0381, 1931, 1944
Siarem.....	0087, 0102, 0213, 0516	Symphonic.....	0180, 0171, 1904, 1913
Siemens.....	0032, 0037, 0146, 0157, 0191, 0195, 0200, 0213, 0327, 0328, 0535, 0554	Synco.....	0000, 0451, 0093, 0060, 0178, 0036, 0092, 0474
Signature.....	0016	Sysline.....	0037
Silva.....	0216	Sytong.....	0216
Silver.....	0179, 0036, 0361	T + A.....	0447
Simpson.....	0186, 0187	TCM.....	0808
Singer.....	0087, 0102	TMK.....	0178, 0056, 0177
Sinu.....	0102	TNCi.....	0017
Sinudyne.....	0010, 0087, 0102, 0177, 0206, 0213, 0235, 0294, 0516	TVS.....	0463
Skantic.....	0356	TVTEXT 95.....	0556
Skygiant.....	0180	Tacico.....	0178, 0179, 0009, 0092, 0474
Skysonic.....	0696	Tactus.....	0272
Skyworth.....	0037	Tai Yi.....	0009
Solavox.....	0032, 0072, 0163, 0361, 0548	Tandberg.....	0367
Sonitron.....	0208, 0339, 0370	Tandy.....	0093, 0039, 0072, 0163, 0217, 0218
Sonoko.....	0282, 0009, 0037	Tashiko.....	0032, 0033, 0036, 0043, 0092, 0146, 0163, 0216, 0217, 0363, 0650, 0721
Sonolor.....	0163, 0208, 0361, 0567	Tatung.....	0054, 0154, 0156, 0051, 0060, 0055, 0003, 0009, 0011, 0036, 0037, 0049, 0072, 0217, 0272, 0338, 0396, 0474, 0516, 0553, 0621
Sontec.....	0009, 0037, 0294, 0370	Teac.....	0282, 0009, 0037, 0264, 0412, 0418, 0455, 0624, 0668, 0698, 0706, 0712, 0721, 1037, 1437, 1904, 1909, 1913, 1932, 1949
Sony.....	0000, 0010, 0011, 0036, 0080, 0102, 0111, 0505, 0650, 0651, 1010, 1505, 1651, 1904, 1925	Tec.....	0009, 0217, 0247, 0259, 0337, 0471, 0474
Sound & Vision.....	0102, 0374	Technema	0320
Soundesign.....	0180, 0178, 0179, 0186	Technics	0250, 0051, 0650
Soundwave.....	0037, 0320, 0418	Technol Ace	0179
Sowa.....	0156, 0051, 0060, 0178, 0036, 0092, 0226, 0338, 0474	Technovox	0007
Spectricon.....	0003, 0137	Techwood	0051, 0056, 0003
Squareview.....	0171	Teco	0051, 0093, 0178, 0009, 0036, 0068, 0092, 0218, 0264, 0280, 0474, 0653
Ssangyong.....	0009, 0032	Teknika	0054, 0180, 0150, 0060, 0019, 0179, 0056, 0016, 0039, 0092, 0186
Stag.....	0032	Teleavia	0196, 0205, 0343, 0399
Standard.....	0009, 0037, 0217, 0218, 0320, 0374	Telefunken	0056, 0005, 0037, 0073, 0074, 0084, 0101, 0109, 0196, 0213, 0262, 0335, 0343, 0471, 0486, 0498, 0566, 0625, 0702
Starlite.....	0180	Telegazi	0037
Stenway.....	0282, 0218	Telemeister	0037, 0320
Stern.....	0163, 0206, 0259, 0264, 0363, 0411	Telesonic	0037
Strato.....	0037, 0264	Telestar	0037, 0579
Stylandia.....	0217		
Sunkai.....	0294, 0355, 0455, 0610		
Sunstar.....	0009, 0037, 0371		
Sunwood.....	0037		

AM271966-00-V1.pdf August 18, 2003

Teletech	0009, 0037, 0337	Vector Research.....	0030
Teleton.....	0036, 0186, 0206, 0217, 0259, 0349, 0363	Vestel.....	0037, 0217
Televideon.....	0216, 0320	Vibrant.....	0272
Temco.....	0294	Victor.....	0250, 0053, 0036, 0160, 0376, 0650, 0653
Tennessee.....	0037	Video Concepts.....	0098
Tensai.....	0009, 0037, 0104, 0105, 0217, 0218, 0247, 0294, 0320, 0371, 0374, 0377	Videologic.....	0216, 0218
Tenson.....	0320	Videosat.....	0247
Tera.....	0030, 0031, 0149, 0466, 0474	Videotechnic.....	0217, 0320
Texet.....	0009, 0216, 0218, 0374	Videoton.....	0356
Thomas.....	1904	Vidikron.....	0054, 0242
Thomson.....	0037, 0109, 0196, 0198, 0205, 0287, 0335, 0343, 0349, 0399, 0471, 0560, 0625, 1447	Vidtech.....	0178, 0019, 0036
Thorn.....	0005, 0035, 0037, 0072, 0073, 0074, 0084, 0104, 0190, 0192, 0193, 0238, 0272, 0278, 0335, 0343, 0361, 0374, 0499, 0505, 0512, 0535, 0553	ViewSonic.....	1755
Thorn-Ferguson.....	0343	Viking.....	0046
Tokai.....	0009, 0037, 0163, 0337, 0448	Vision.....	0217, 0320
Tokyo.....	0035, 0329, 0448	Vistar.....	0206
Tomashi.....	0282	Voxson.....	0087, 0163, 0363, 0418
Toshiba.....	0154, 0156, 0060, 0035, 0036, 0070, 0102, 0109, 0149, 0161, 0243, 0381, 0502, 0508, 0509, 0553, 0618, 0644, 0650, 0718, 1256, 1508, 1704, 1918, 1935, 1936, 1945	Waltham.....	0037, 0109, 0217, 0356, 0385, 0418
Tosonic.....	0185	Wards.....	0054, 0165, 0030, 0178, 0021, 0019, 0179, 0056, 0016, 0020, 0027, 0028, 0029, 0080, 0096, 0111, 0174, 0866
Totevision.....	0039	Watson.....	0009, 0037, 0213, 0218, 0320, 0394, 0519, 0579
Trans Continens.....	0217	Watt Radio.....	0102, 0213, 0216
Transonic.....	0698, 0712	Waycon.....	0156
Trical.....	0157	Wega.....	0036, 0037, 0087
Trident.....	0516	Wegavox.....	0009
Tristar.....	0193, 0218	Weltblick.....	0320
Triumph.....	0177, 0243, 0346, 0516, 0556	White Westinghouse...	0463, 0037, 0186, 0216, 0320, 0337, 0623, 1909
Tsoschi.....	0282	Windstar.....	0282
Tuntex.....	0030, 0009, 0092, 0474	Xrypton.....	0037
Uher.....	0037, 0206, 0303, 0320, 0374, 0418, 0486	Yamaha.....	0030, 0019, 0769
Ultra.....	0192, 0391	Yamishi.....	0282, 0217, 0455
Ultravox.....	0037, 0087, 0102, 0213, 0216, 0247	Yapshe.....	0250
Unic Line.....	0037, 0473	Yokan.....	0037
United.....	0037	Yoko.....	0009, 0037, 0217, 0218, 0264, 0339, 0421
Universal.....	0027	Zanussi.....	0206, 0217, 0363
Universum.....	0009, 0010, 0011, 0032, 0036, 0037, 0070, 0074, 0076, 0104, 0105, 0146, 0157, 0170, 0177, 0213, 0217, 0247, 0264, 0290, 0294, 0327, 0337, 0346, 0361, 0370, 0411, 0418, 0421, 0474, 0480, 0492, 0505, 0512, 0535, 0554, 1901	Zenith.....	0017, 0463, 0178, 0016, 0092, 0624, 1904, 1909, 1911, 1929
Univox.....	0037, 0087, 0163, 0238, 0337	Zenor.....	0339
		Zonda.....	0003



*AM271966\_00\_V.pdf August 18, 2003*

***BOSE***<sup>®</sup>  
*Better sound through research*<sup>®</sup>

*AM271966\_00\_V.pdf August 18, 2003*

271966 Rev. 00 JN40404